

e

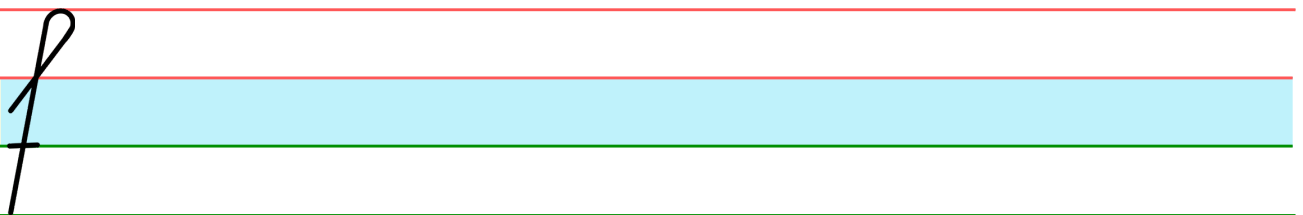

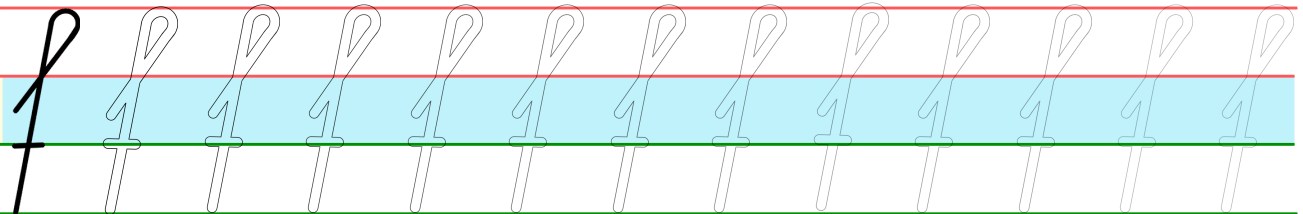

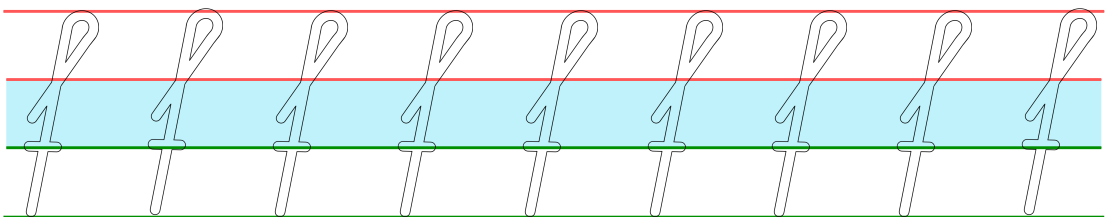

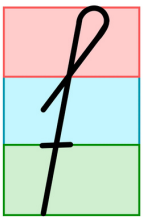
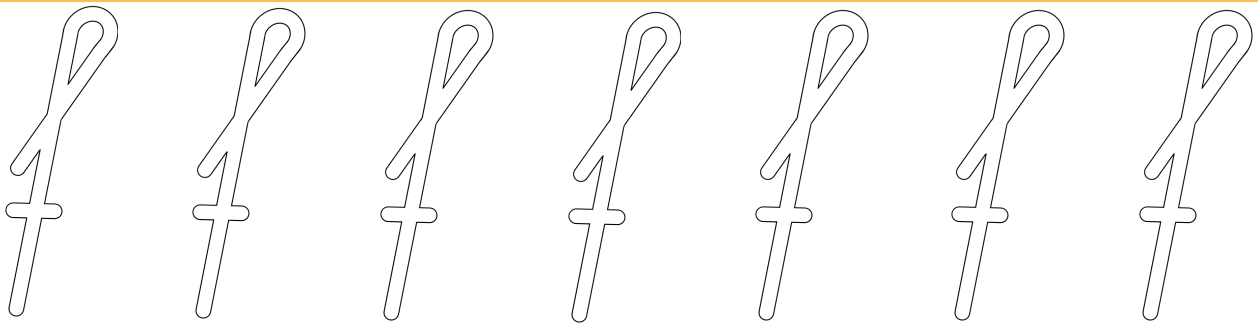
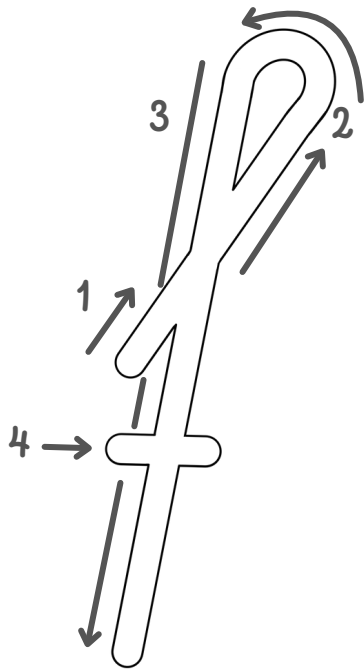
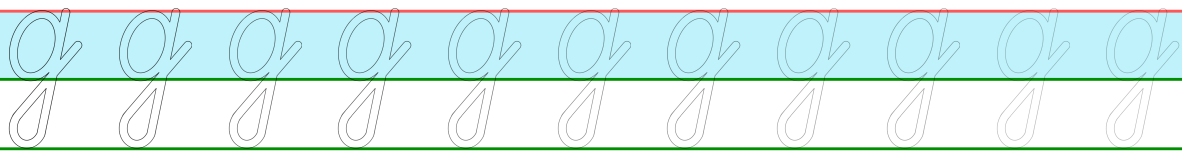
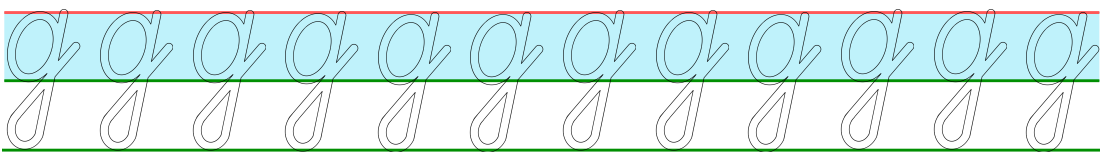
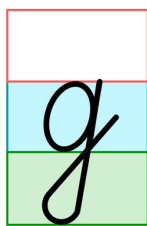
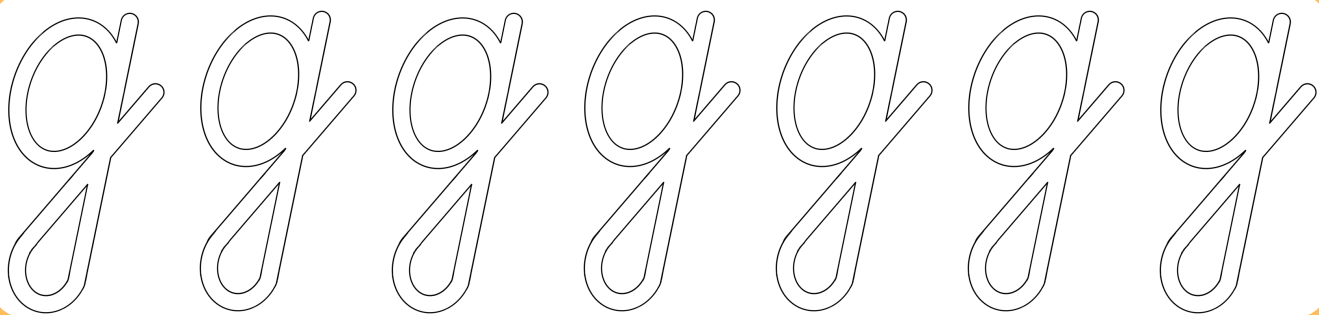
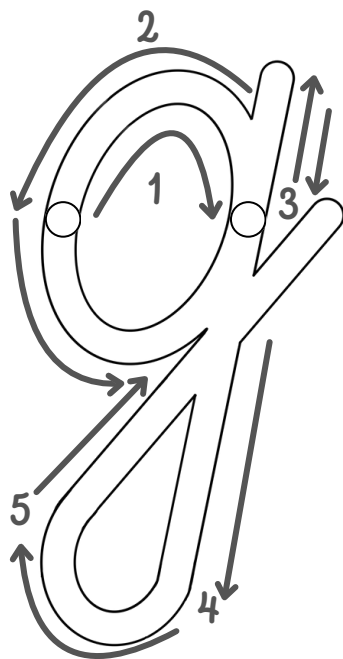
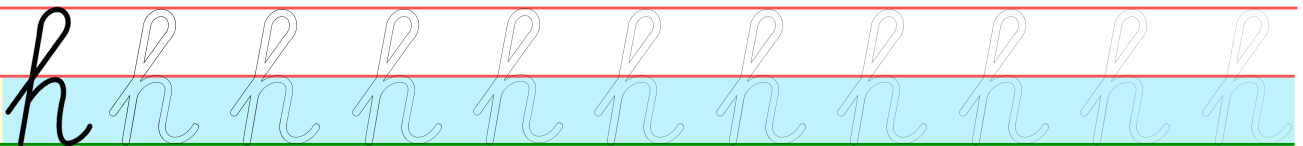
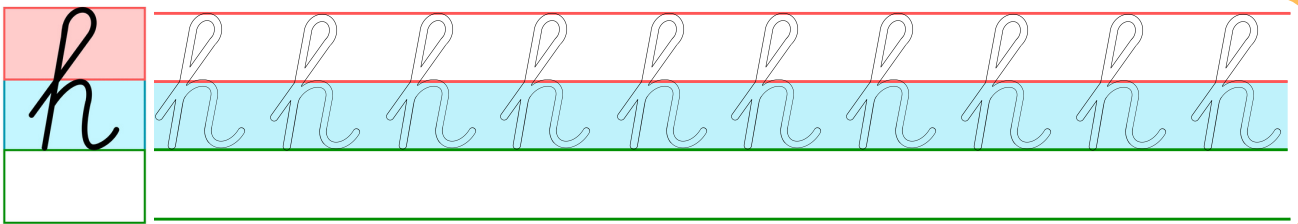
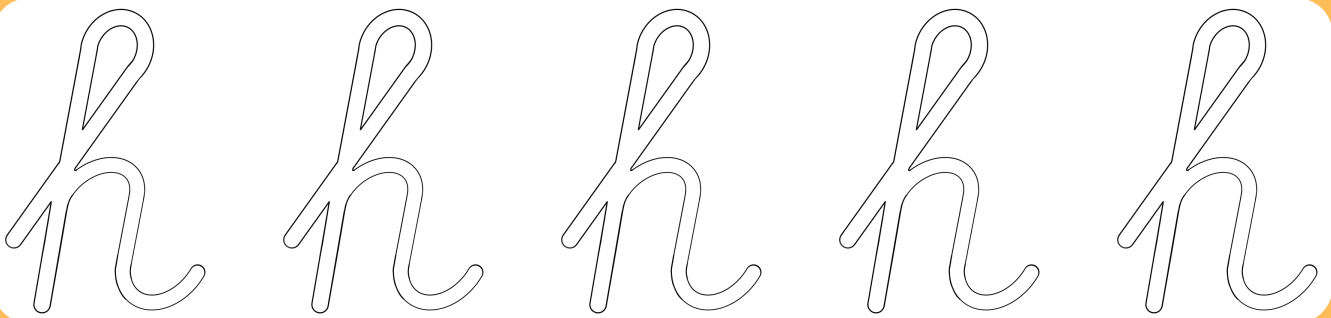
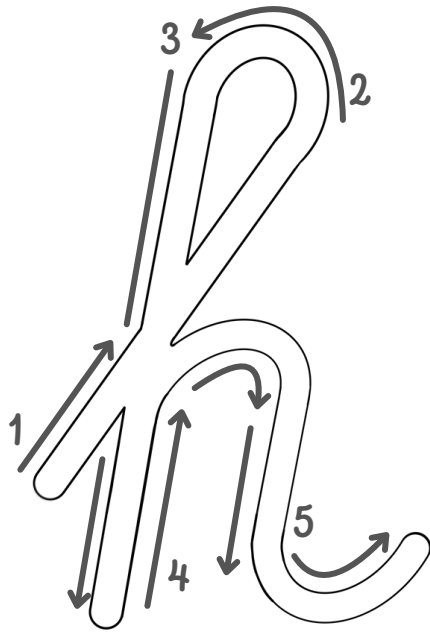
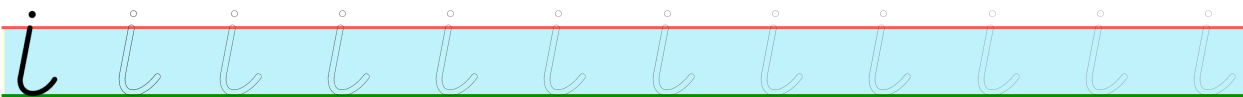
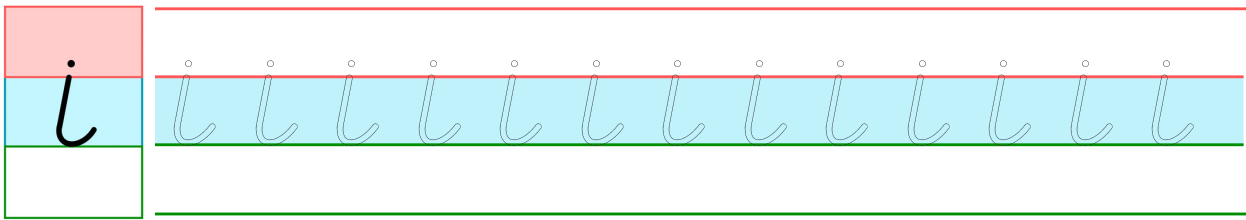
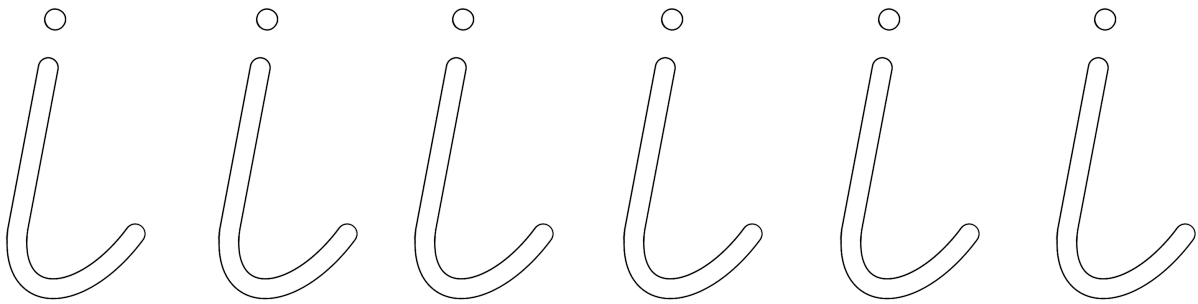
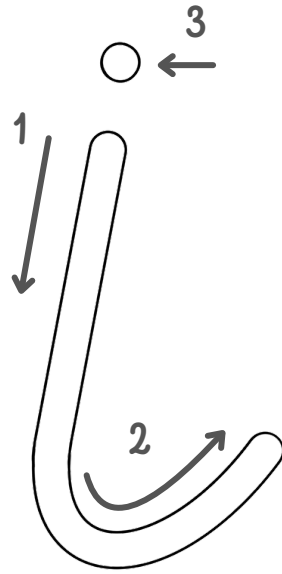



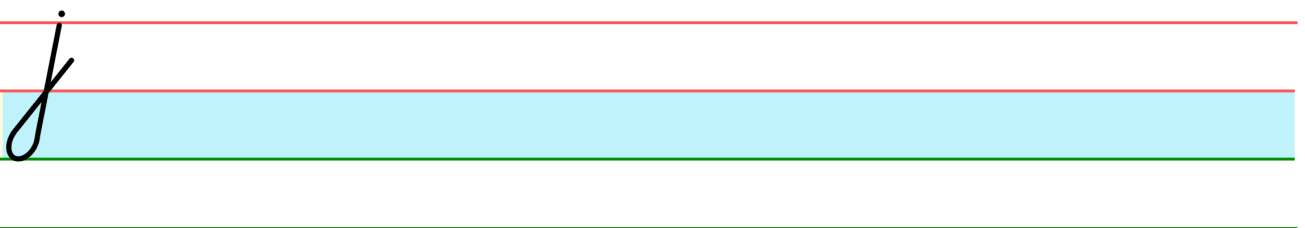
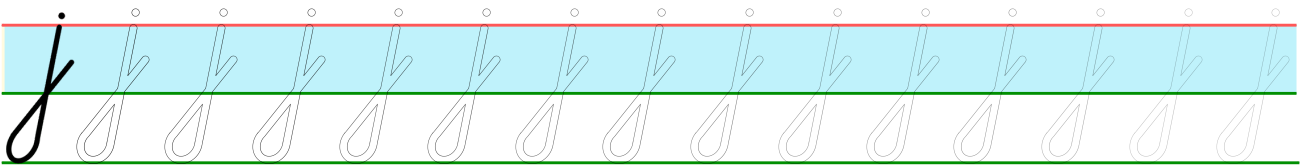
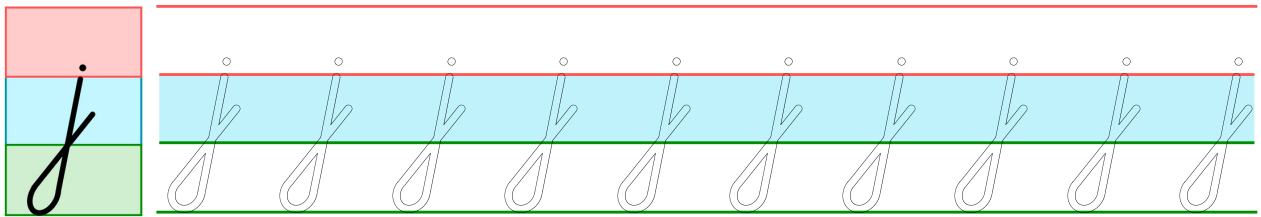
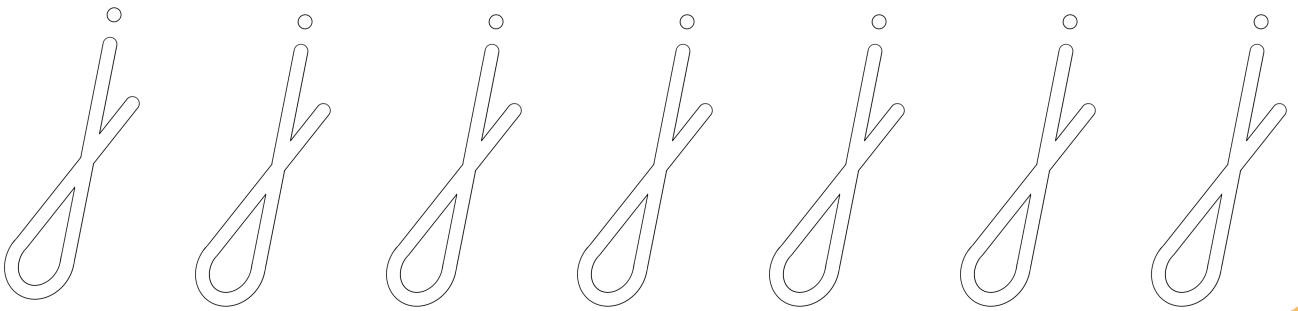
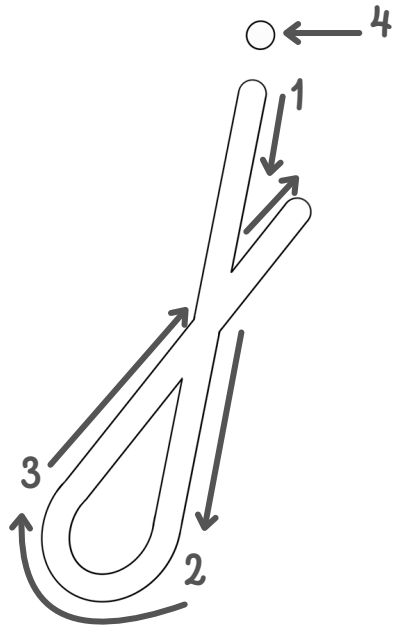

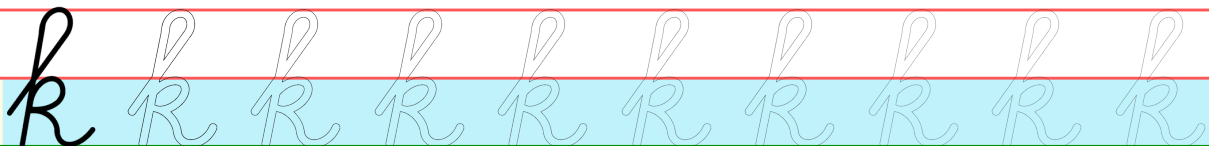
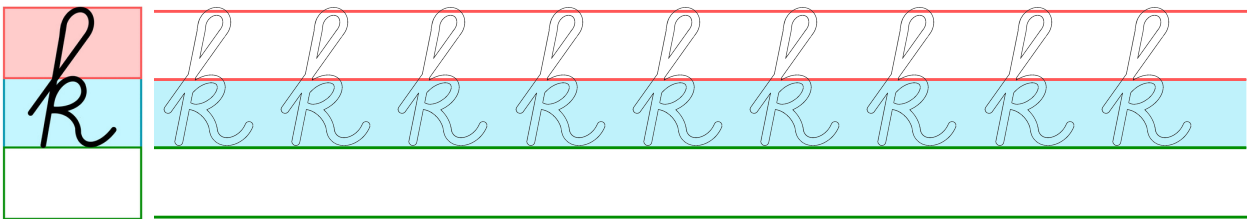
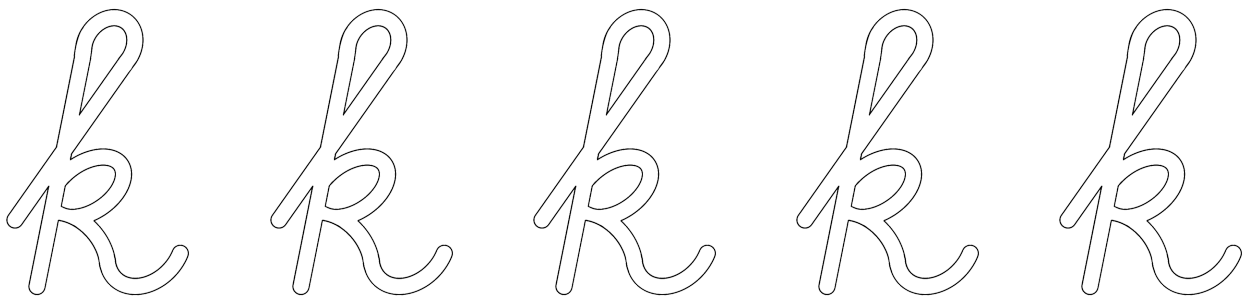
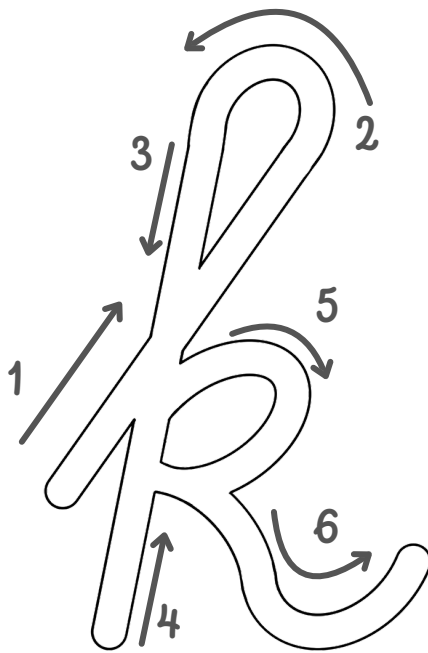

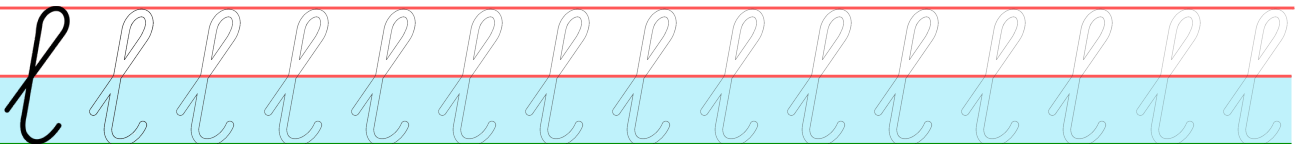
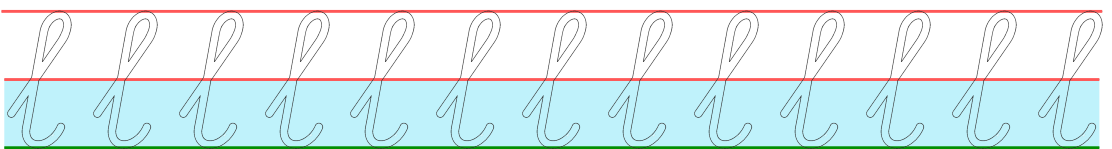
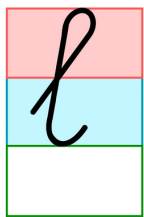
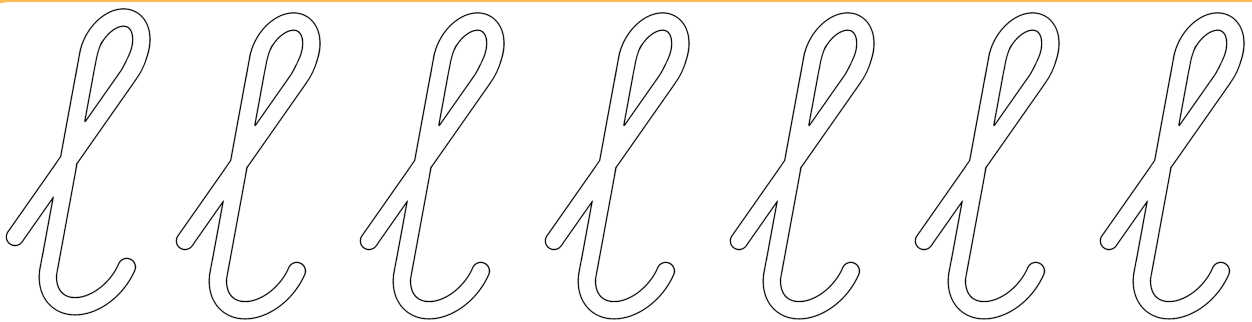
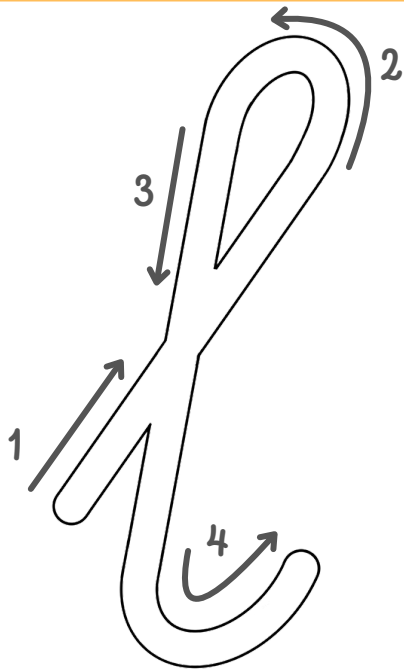

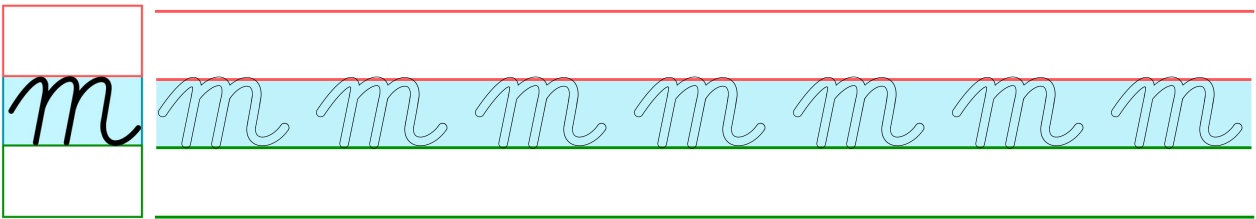
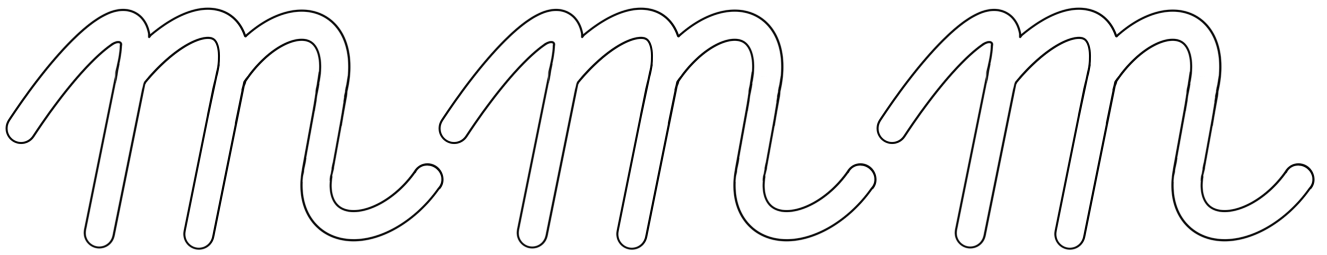
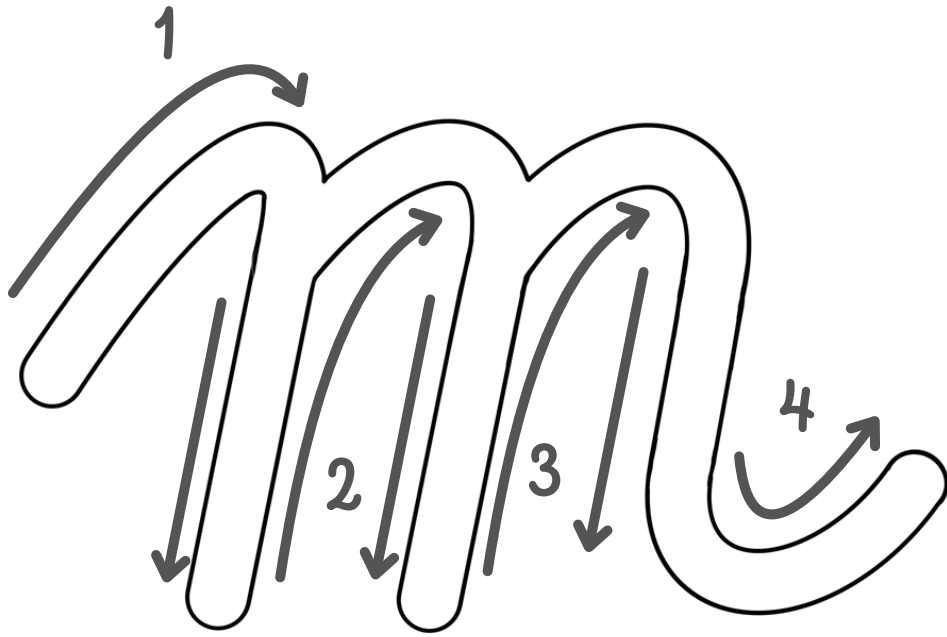

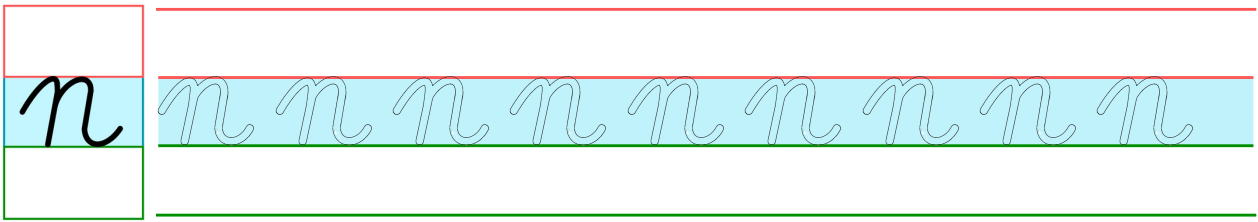
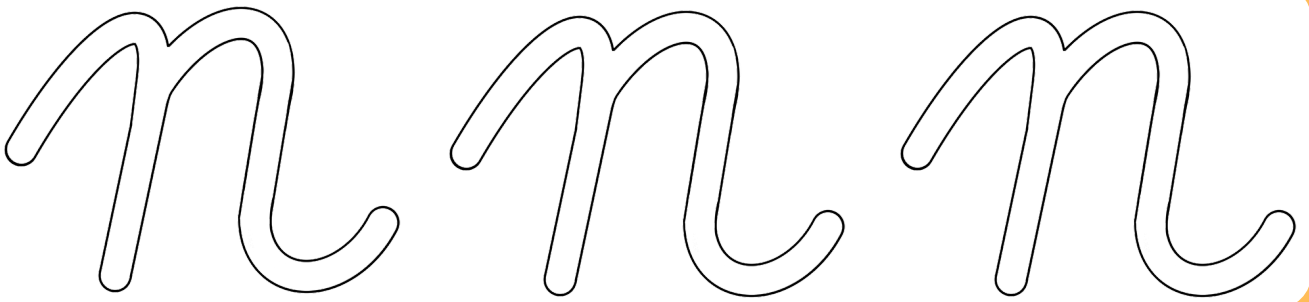
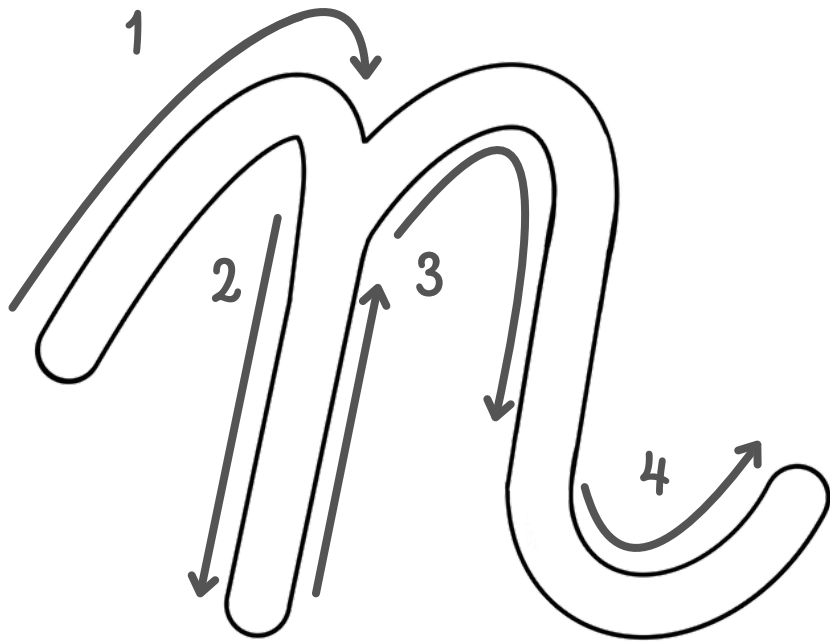

n

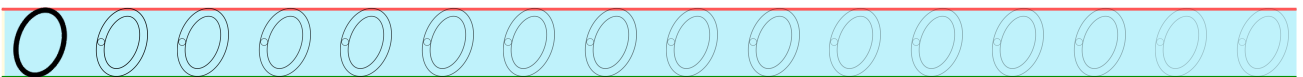
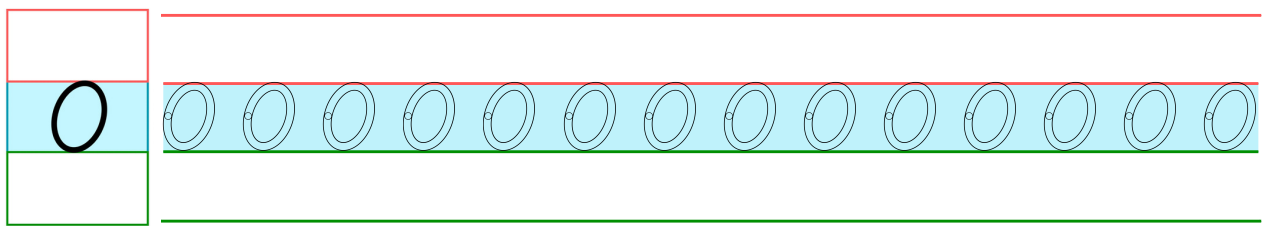
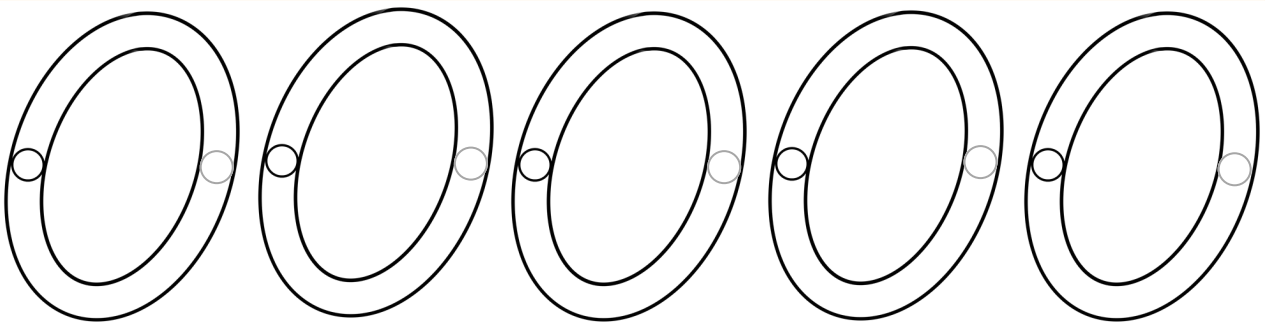
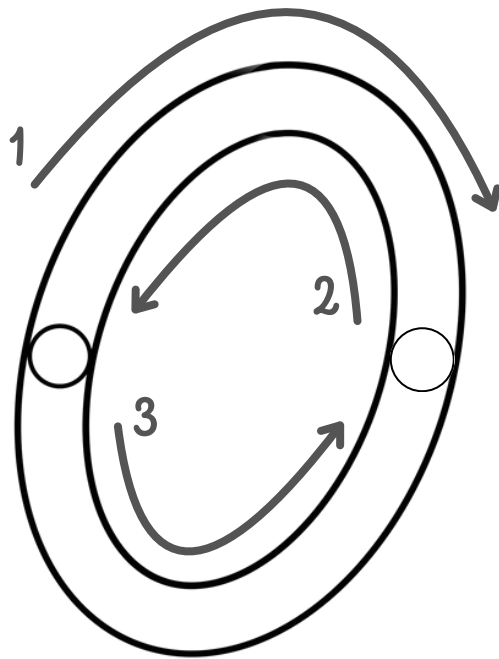

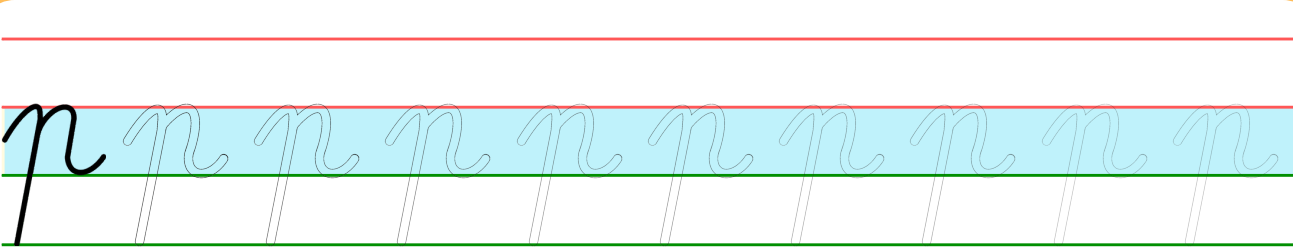
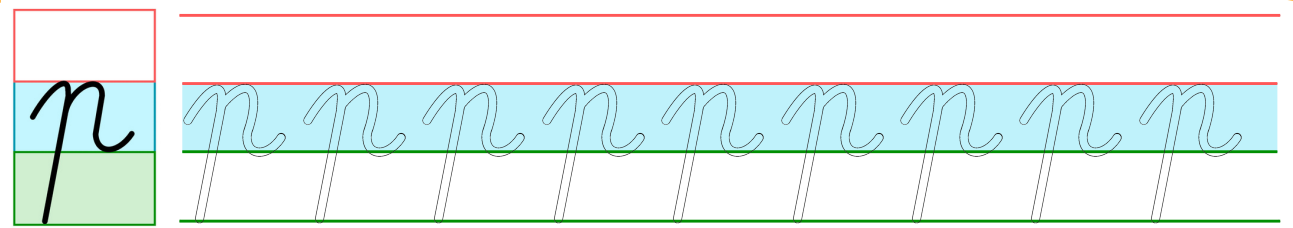
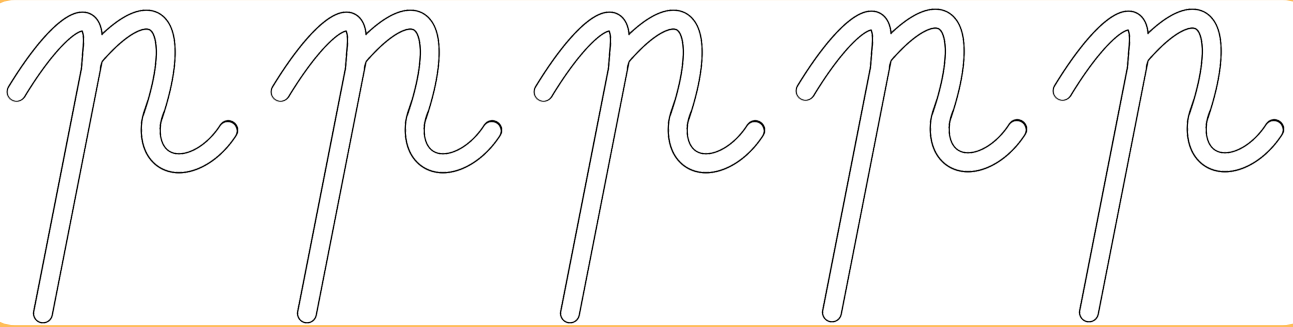
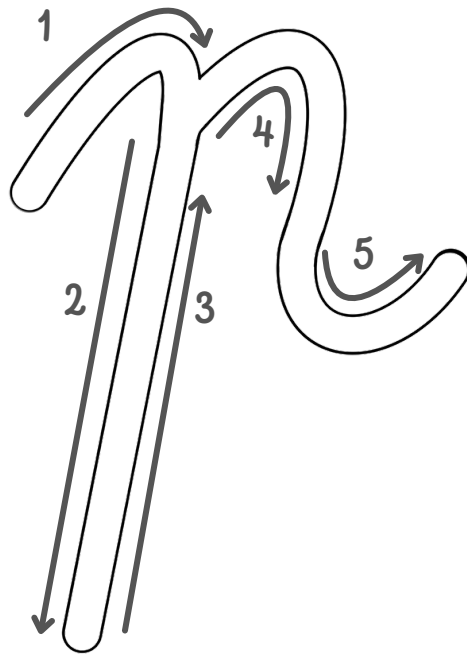

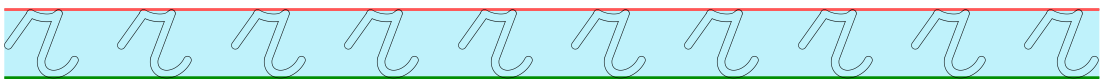
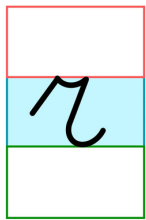
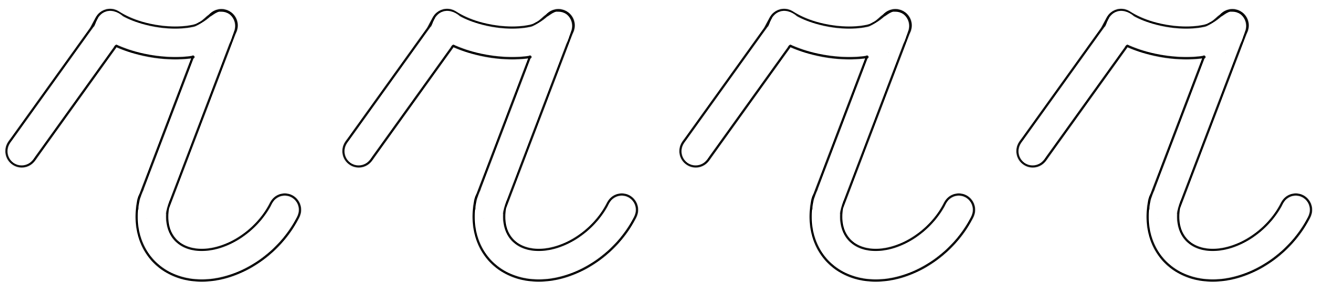
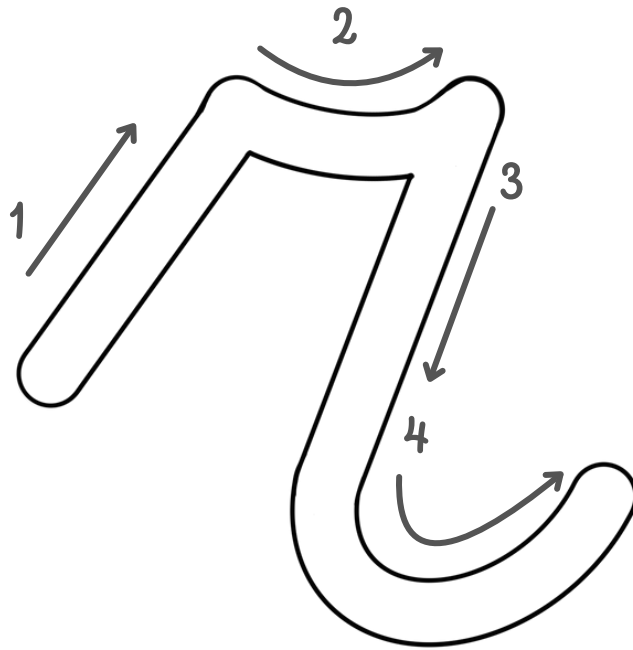



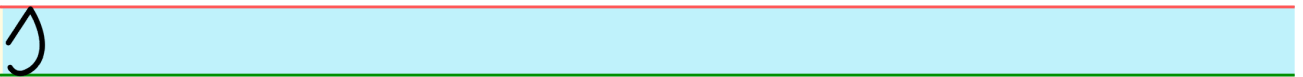
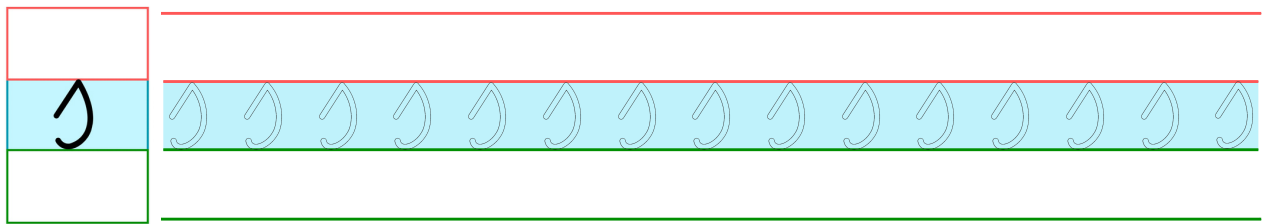
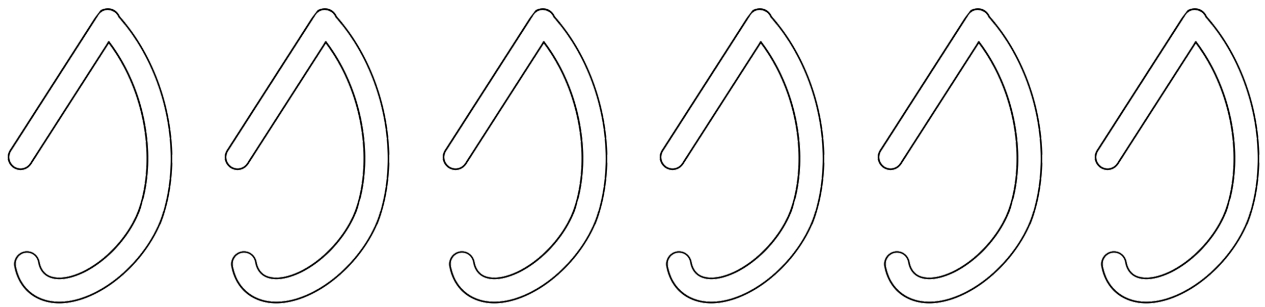
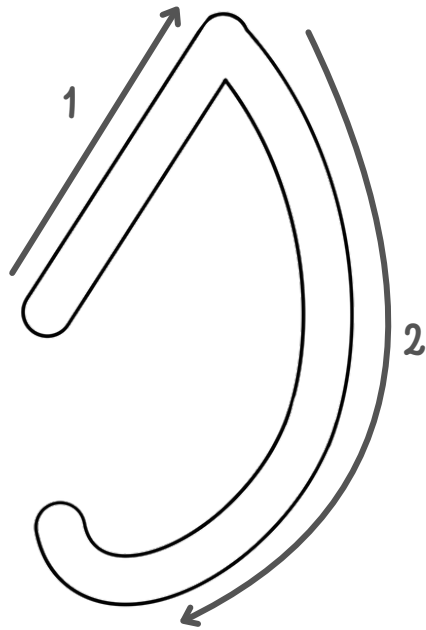

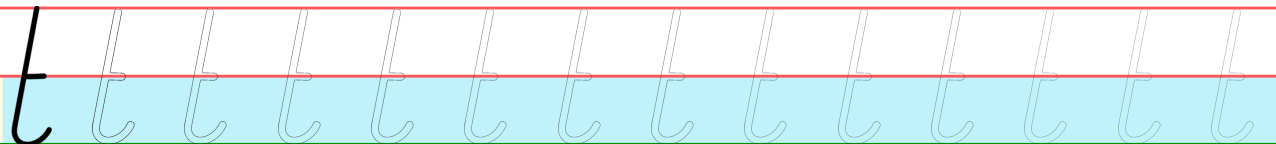
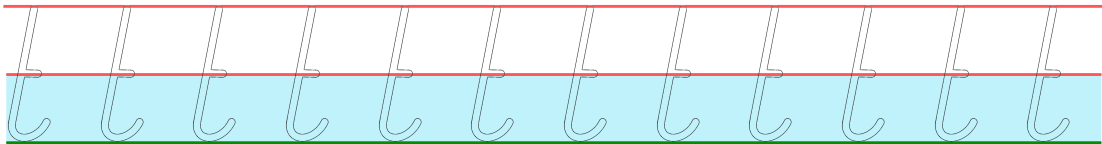
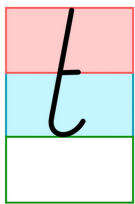
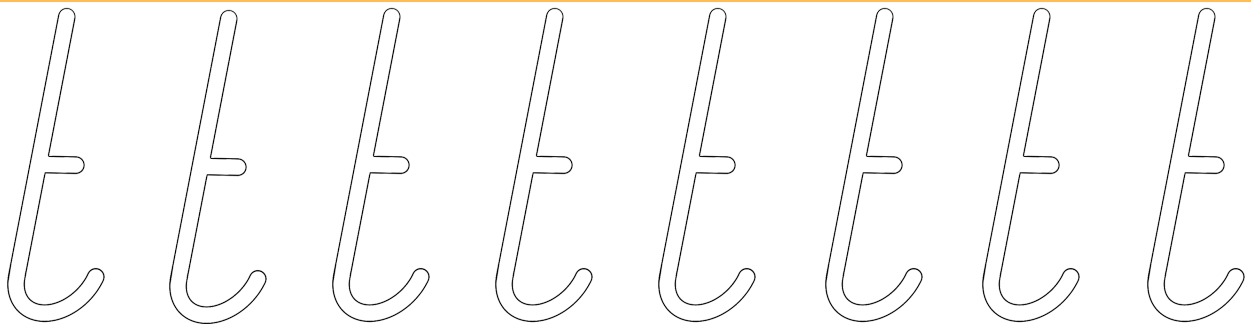
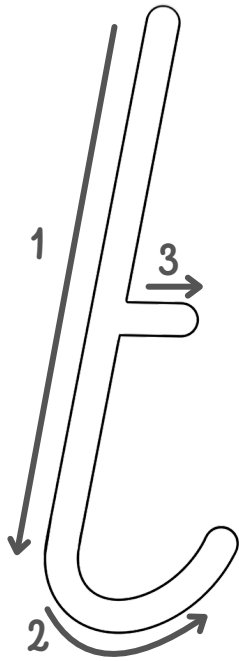

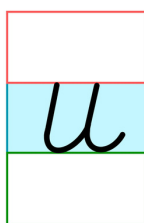
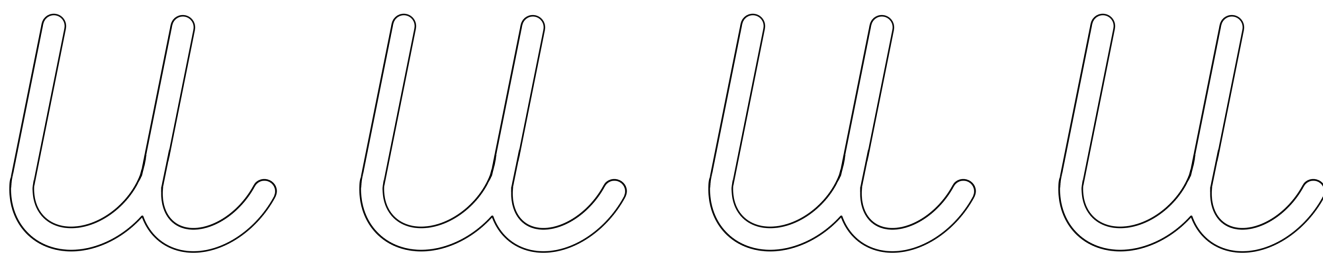
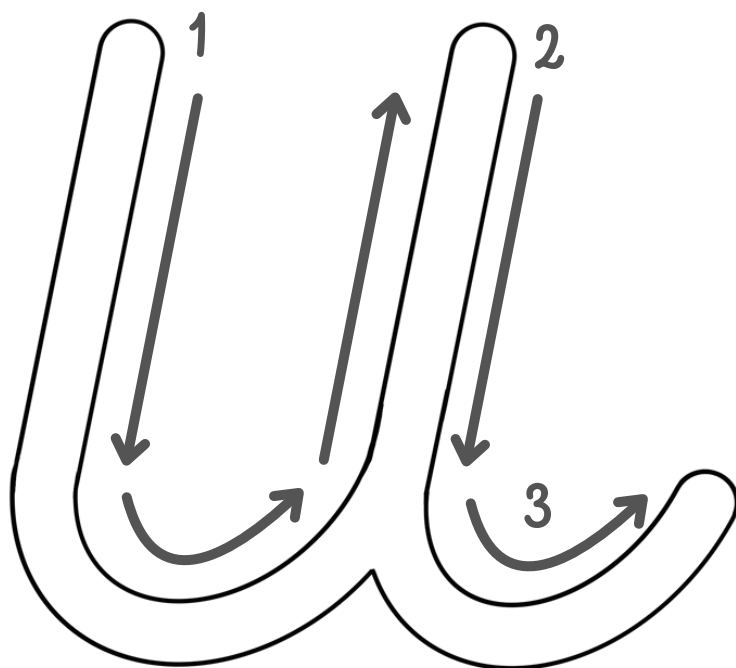

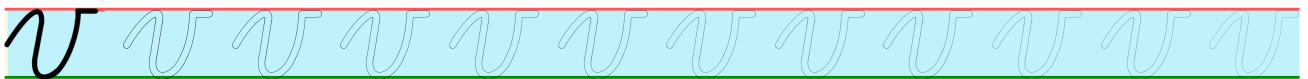
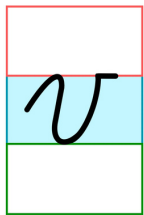
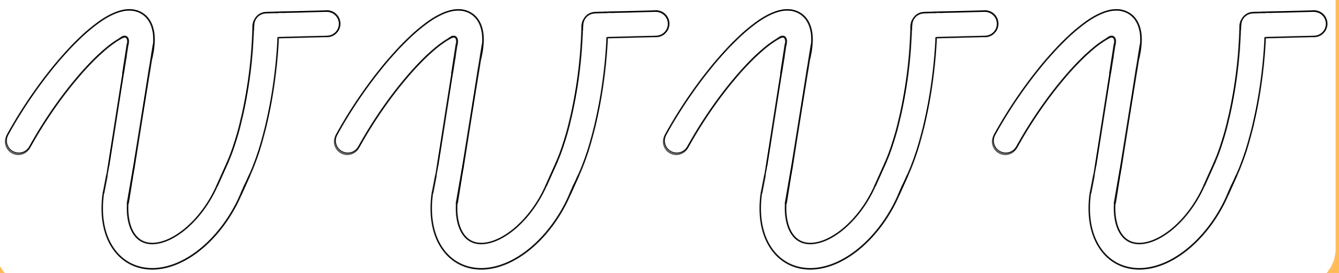
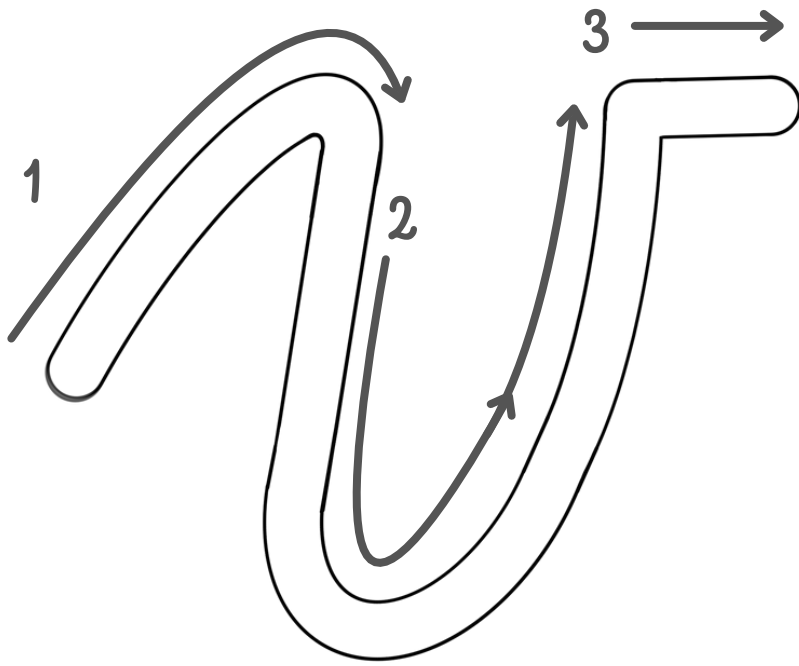

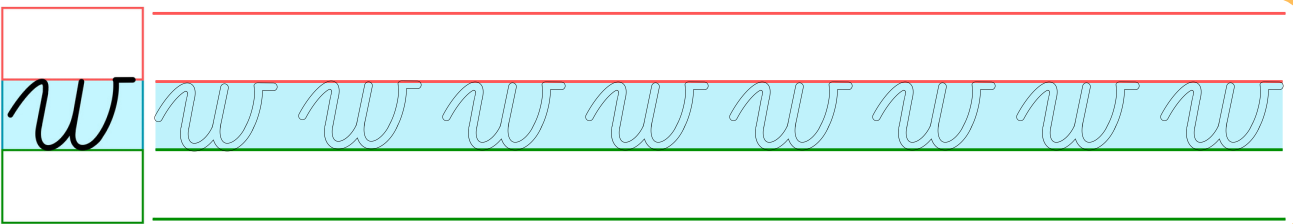
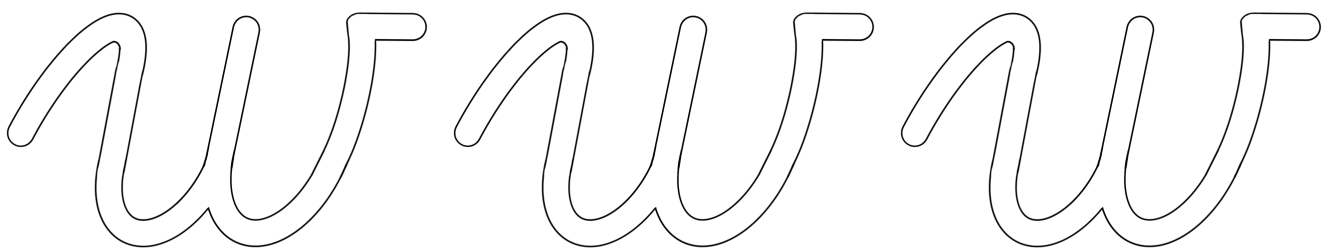
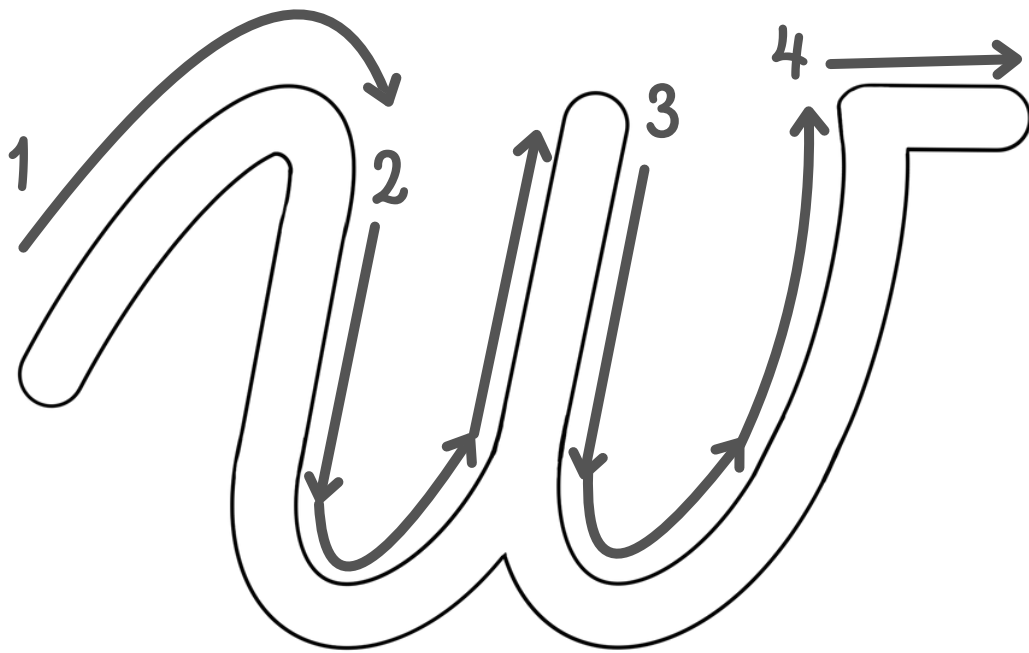

w

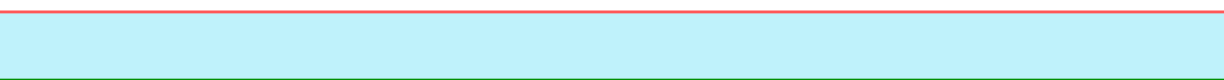
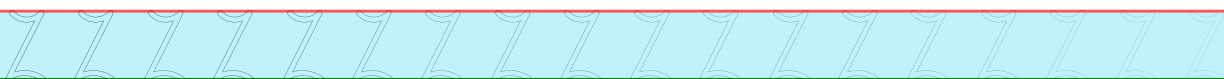
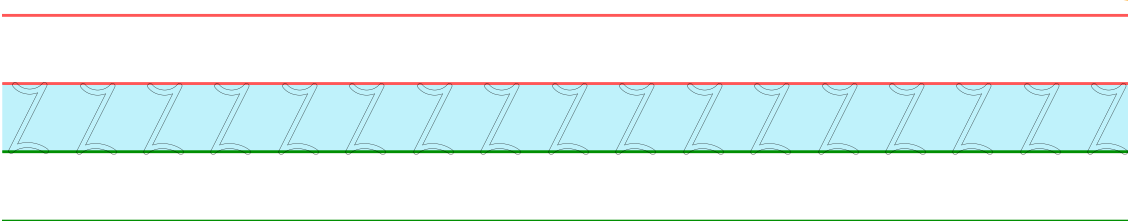
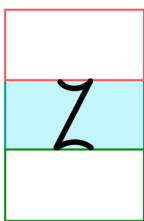
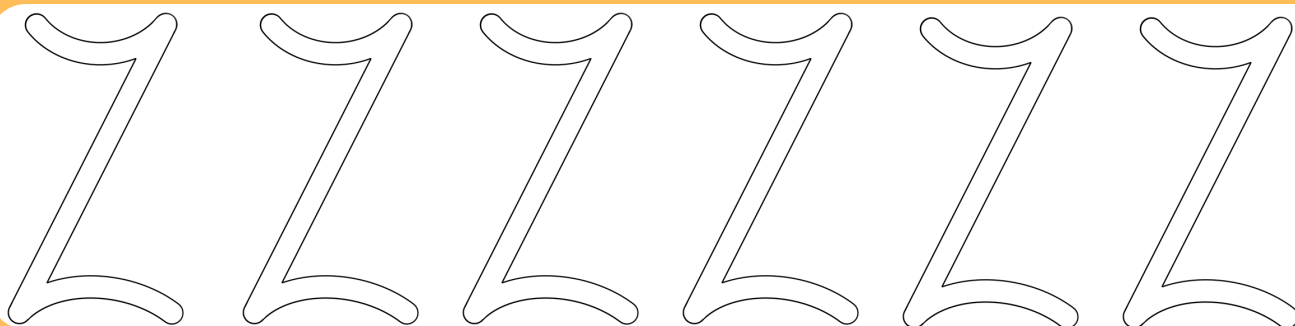
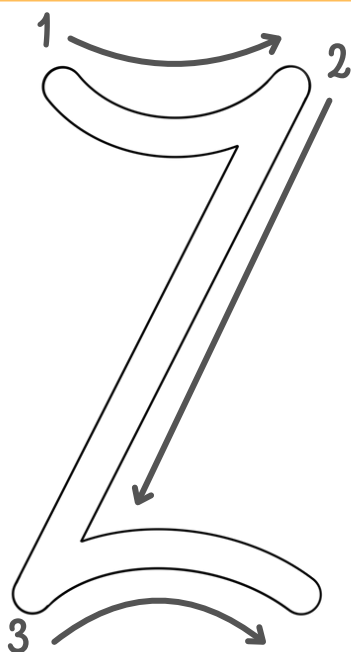

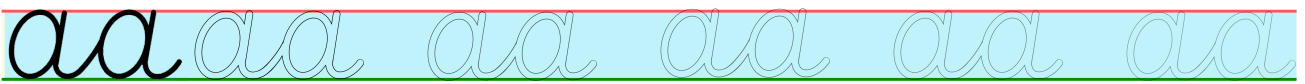
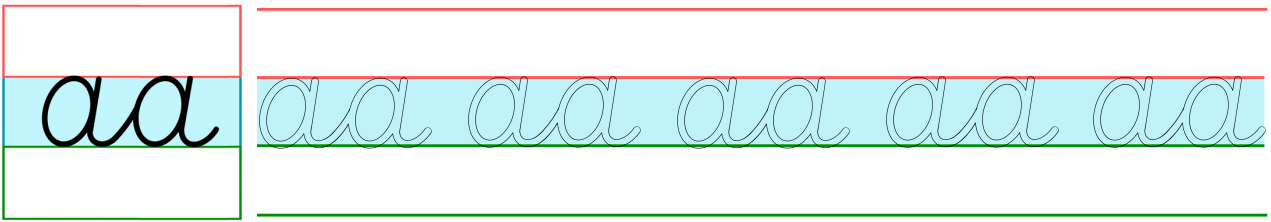
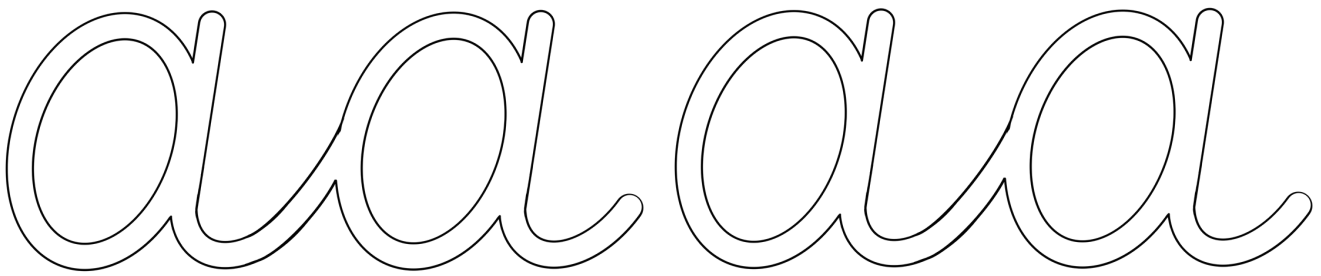
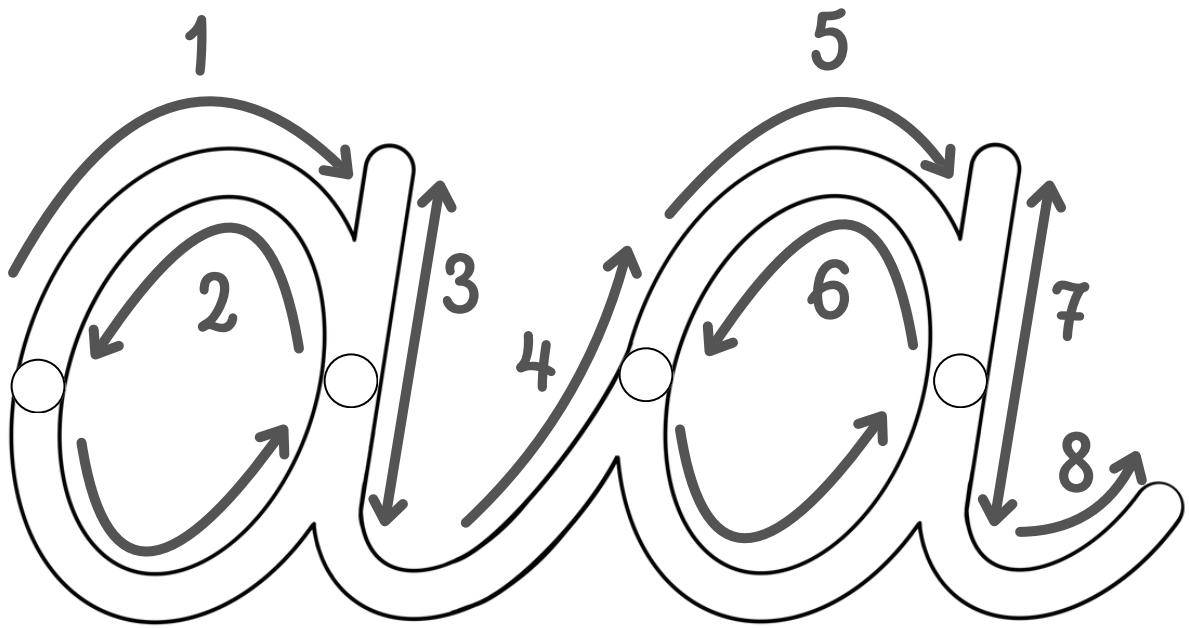

aa

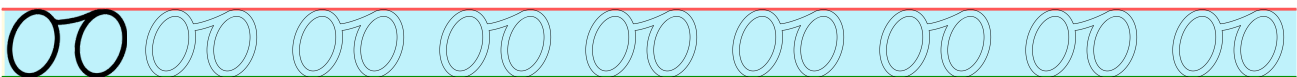
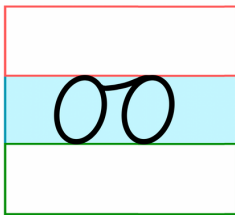
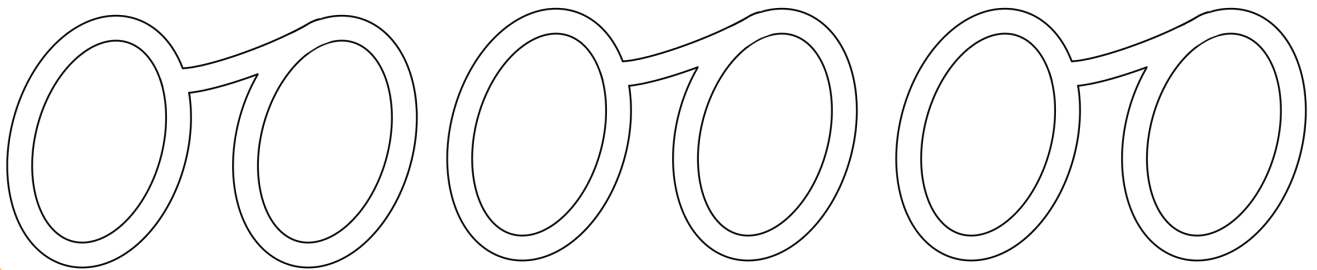
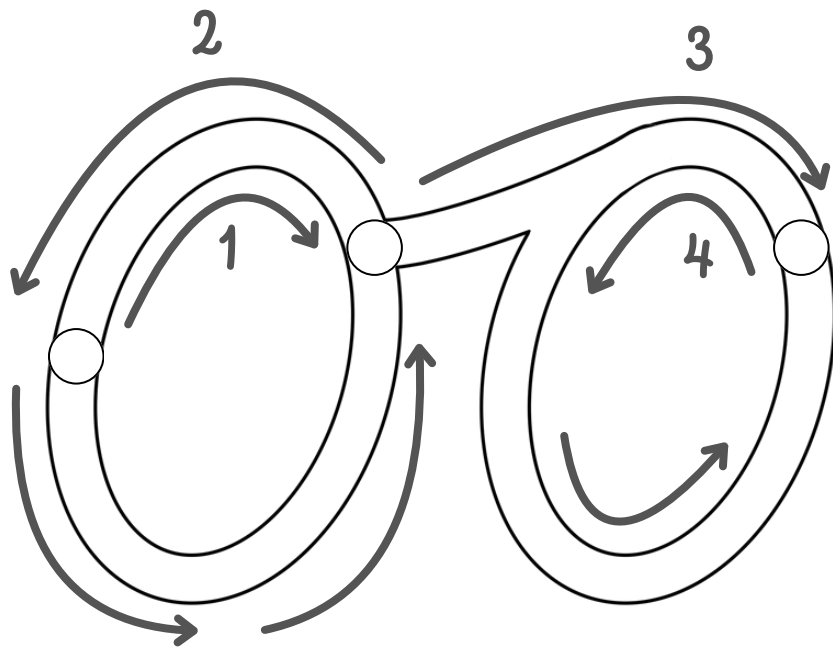



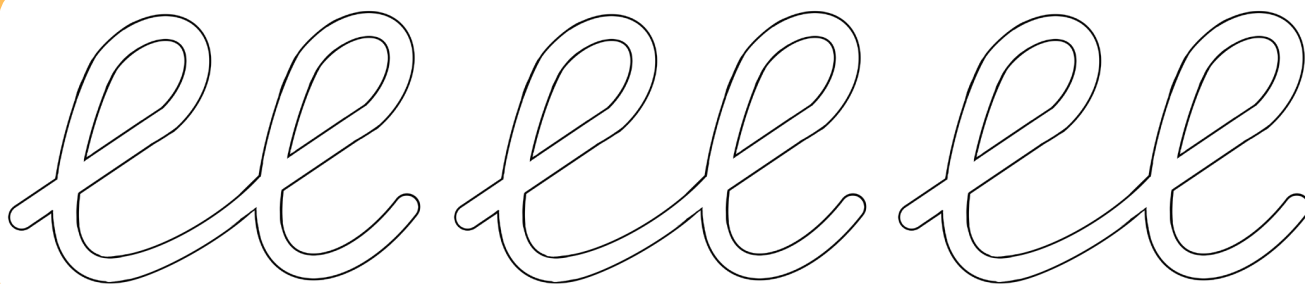
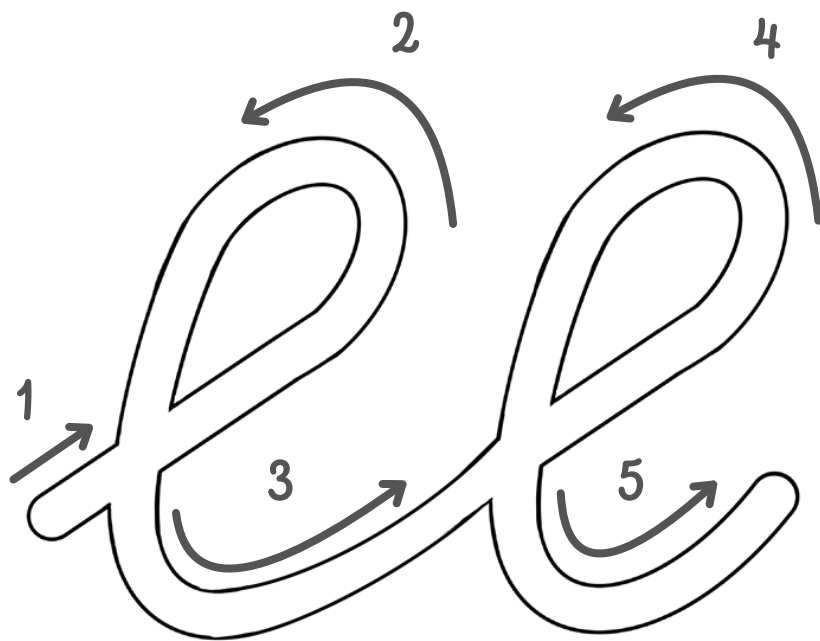

ee

ee ee ee ee ee ee ee ee

ee ee ee ee ee ee ee ee ee ee

ee

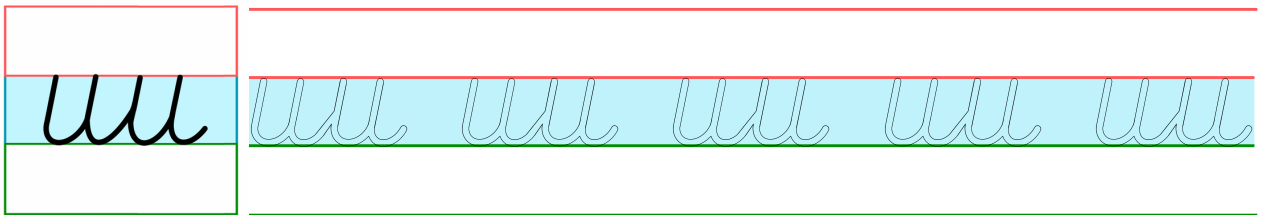
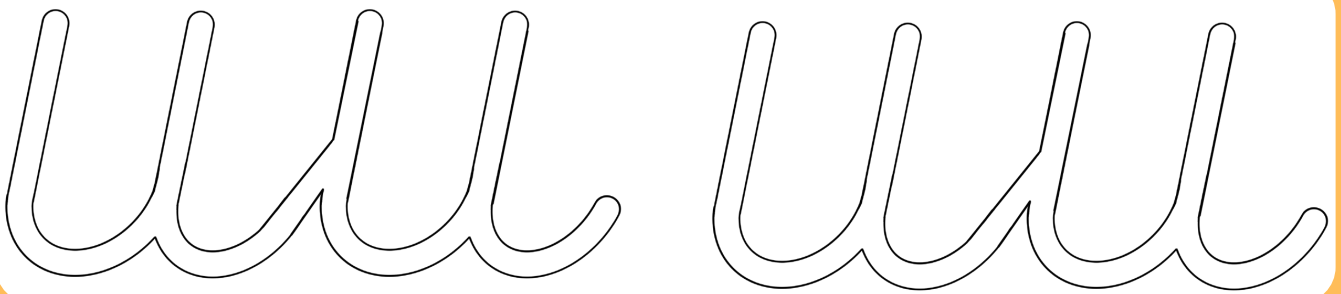
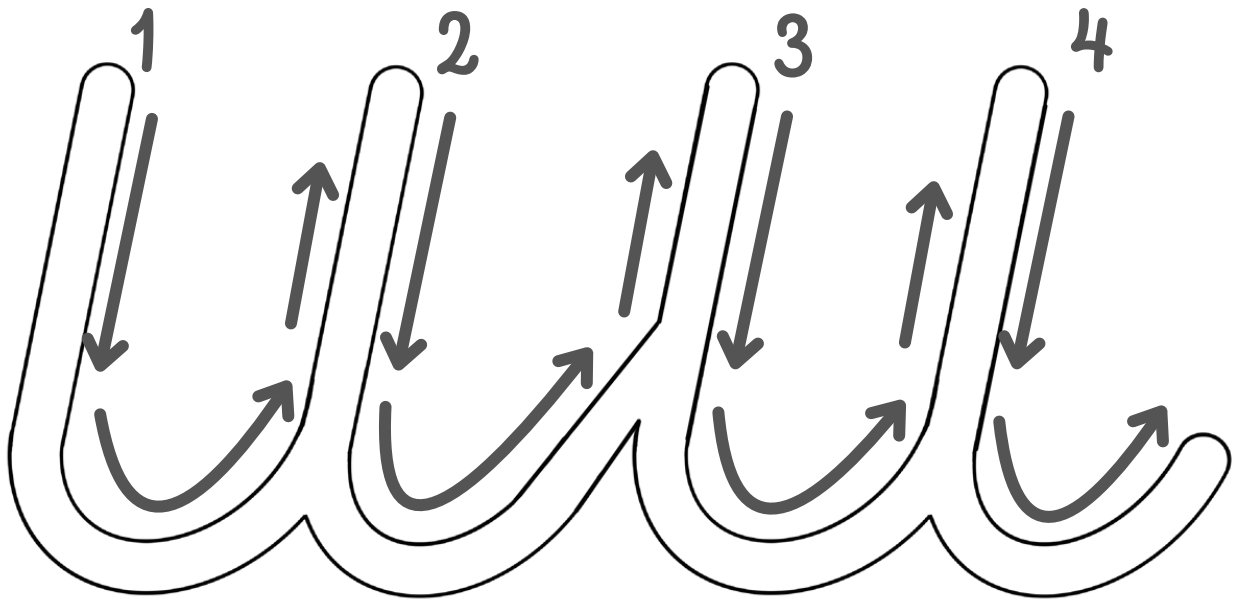

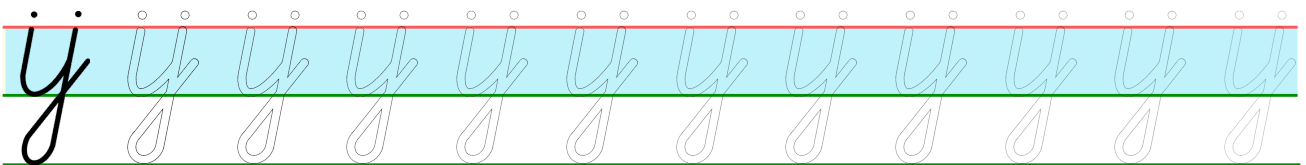
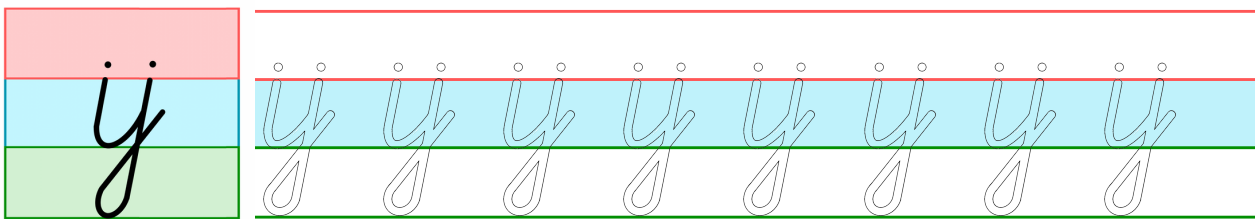
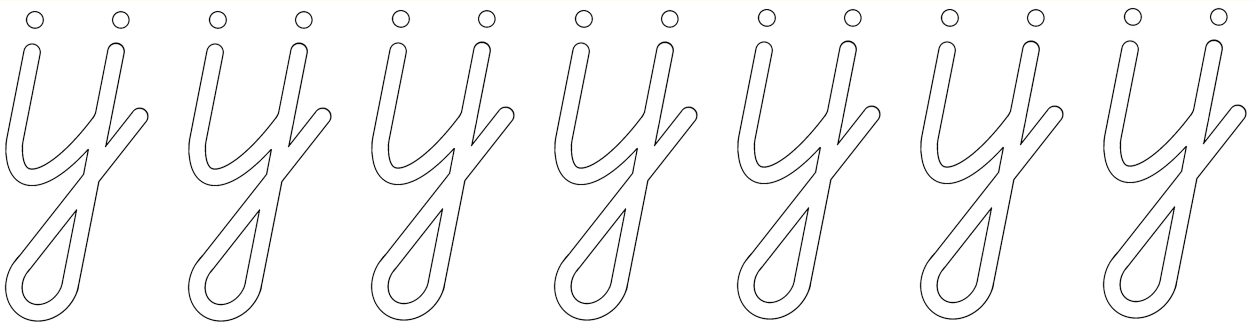
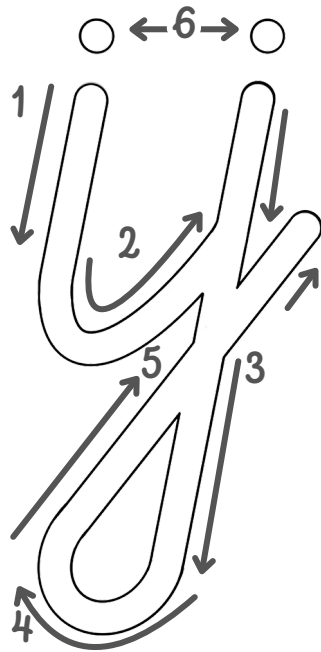

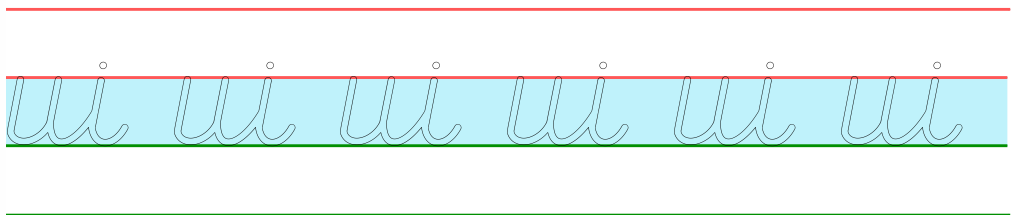
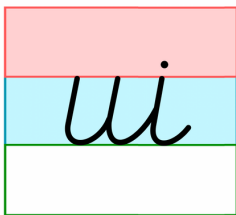
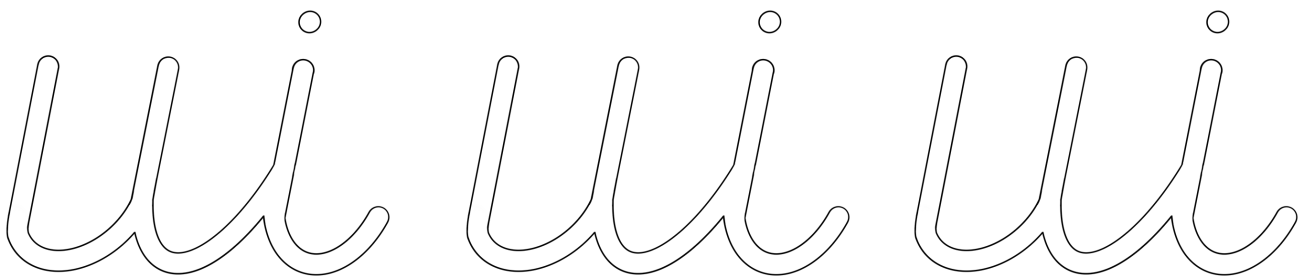
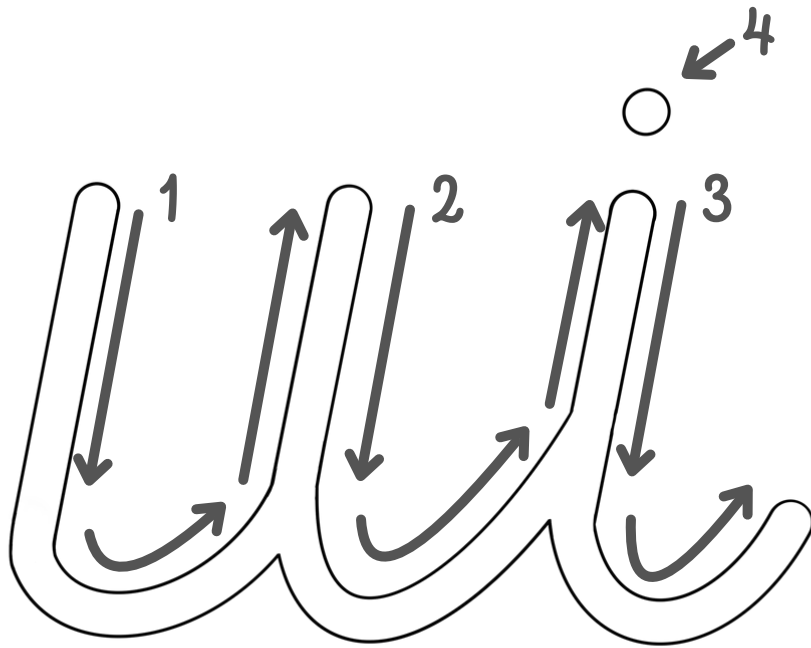

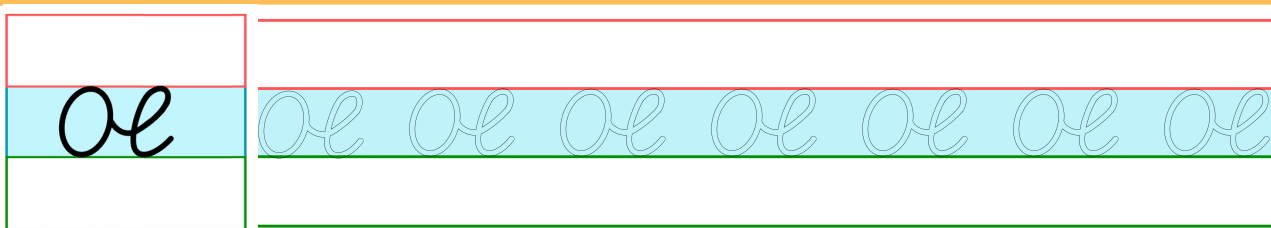
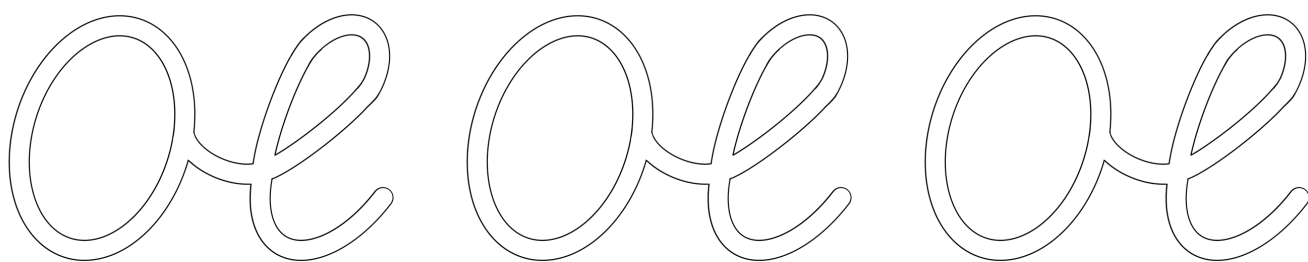
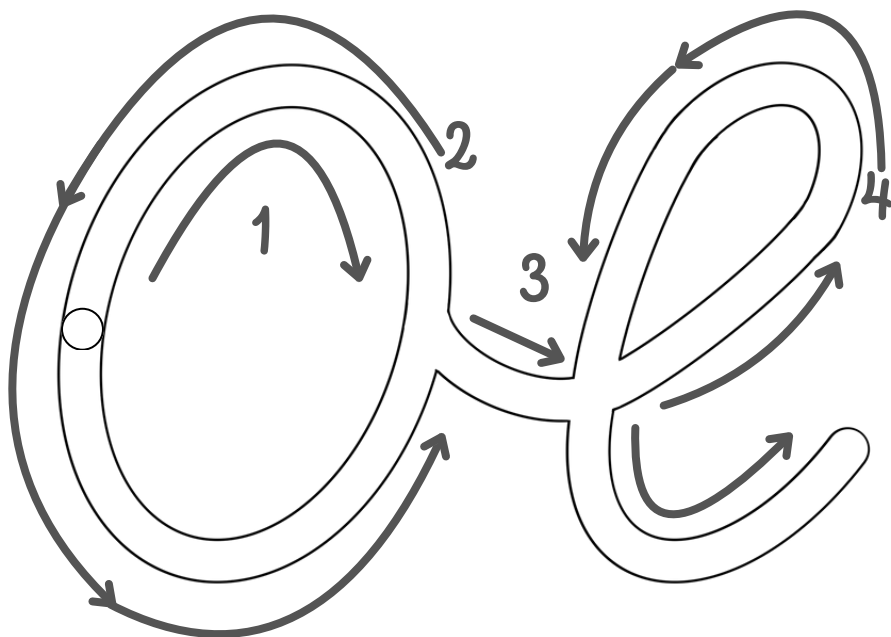

oe

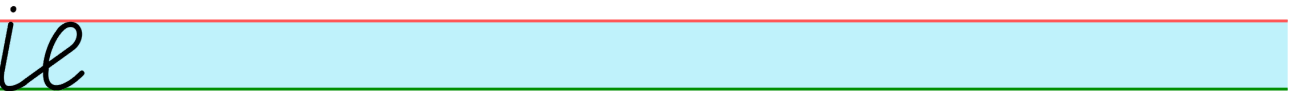
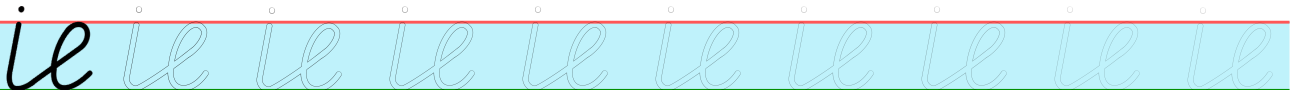
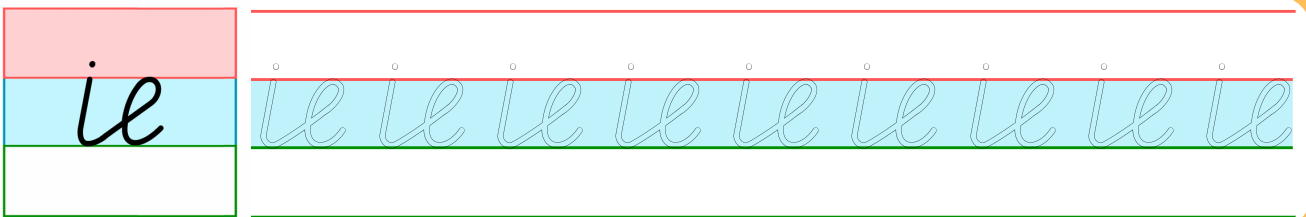
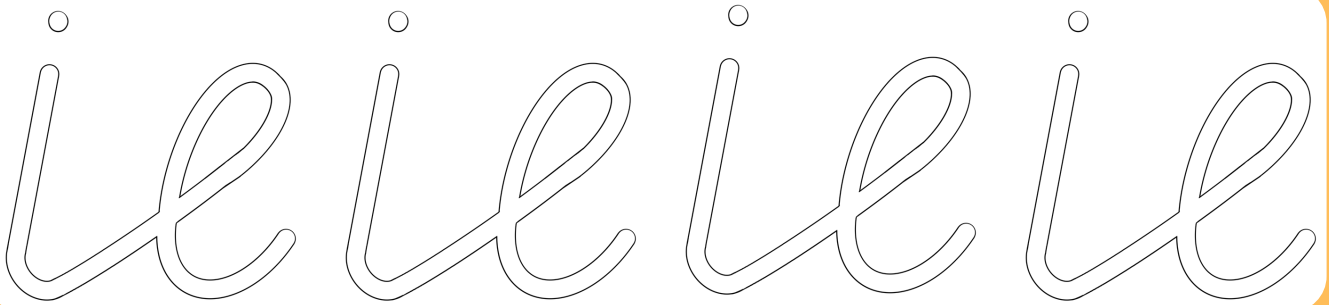
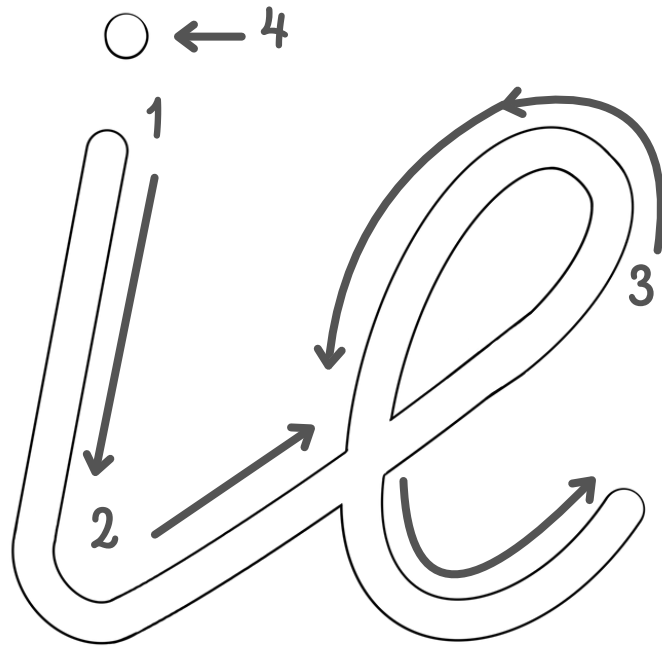

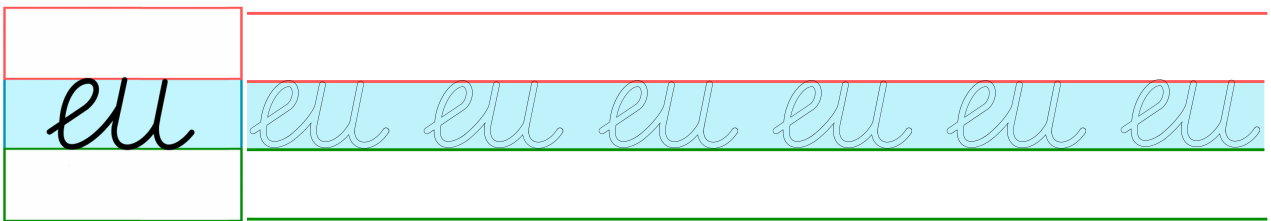
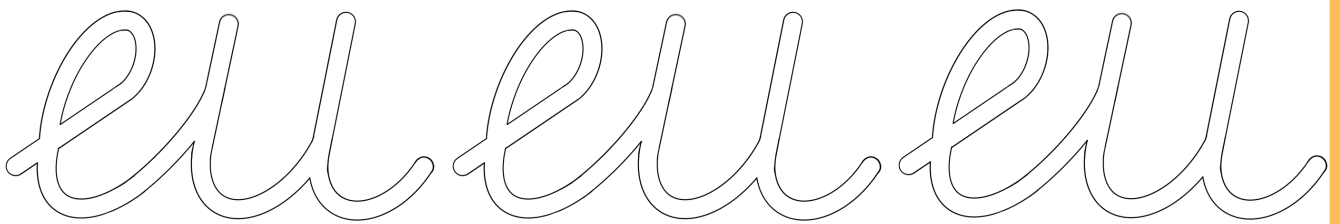
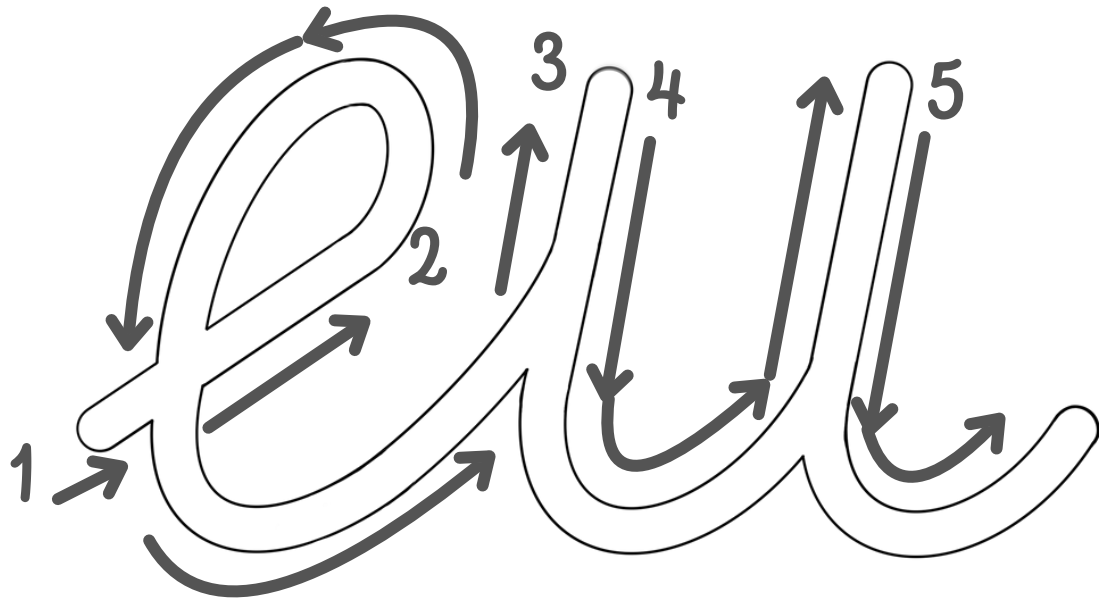

eu

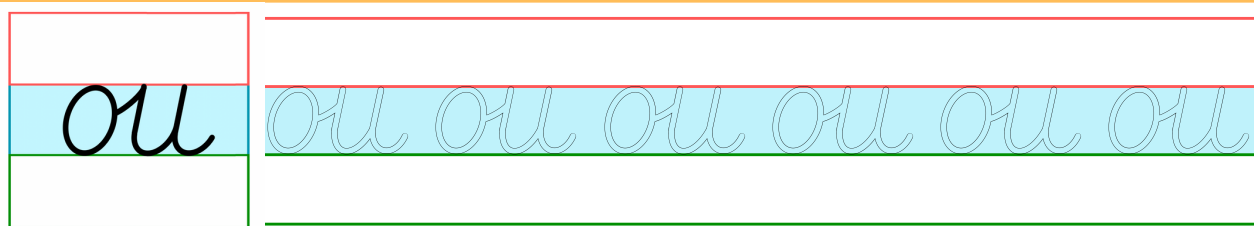
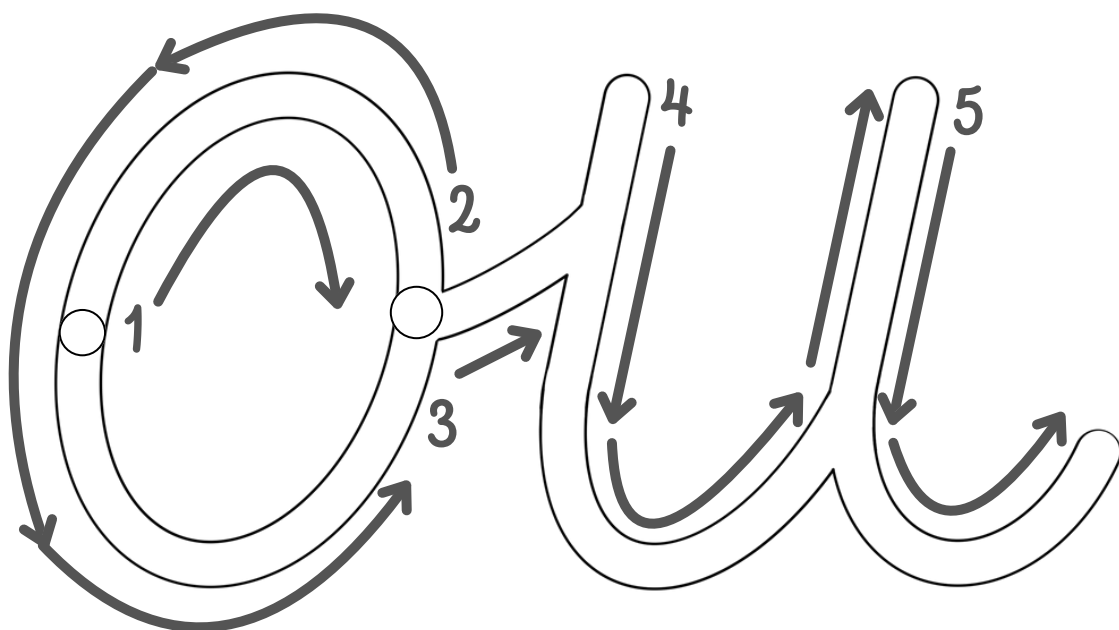

ou



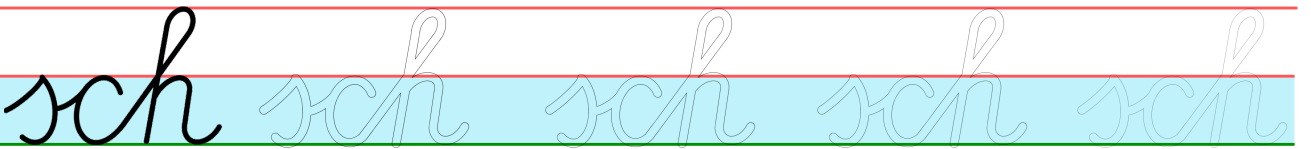
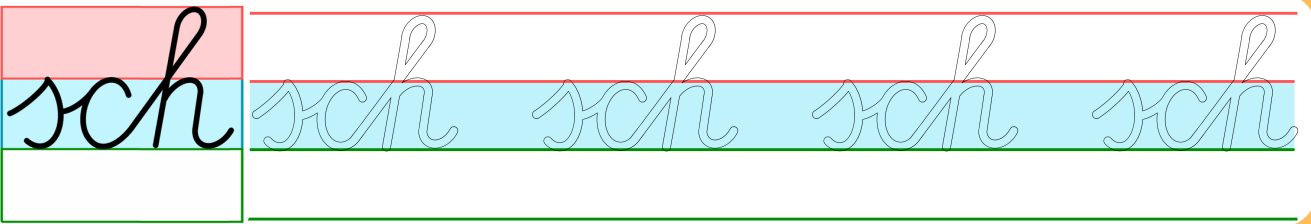
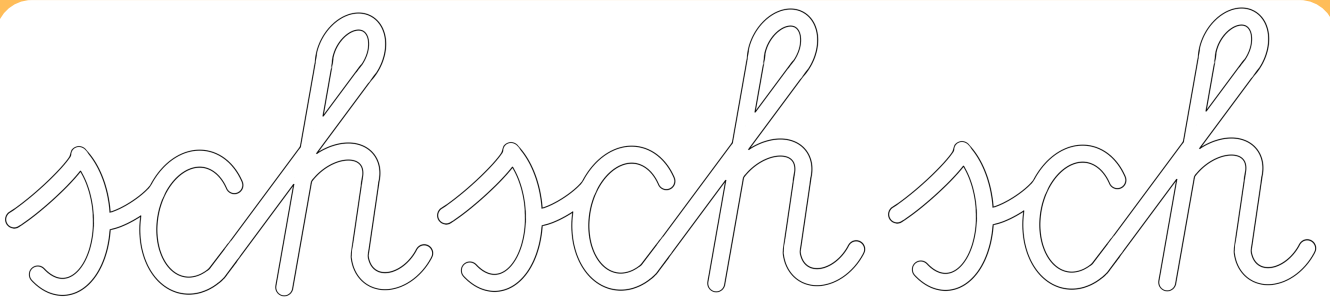
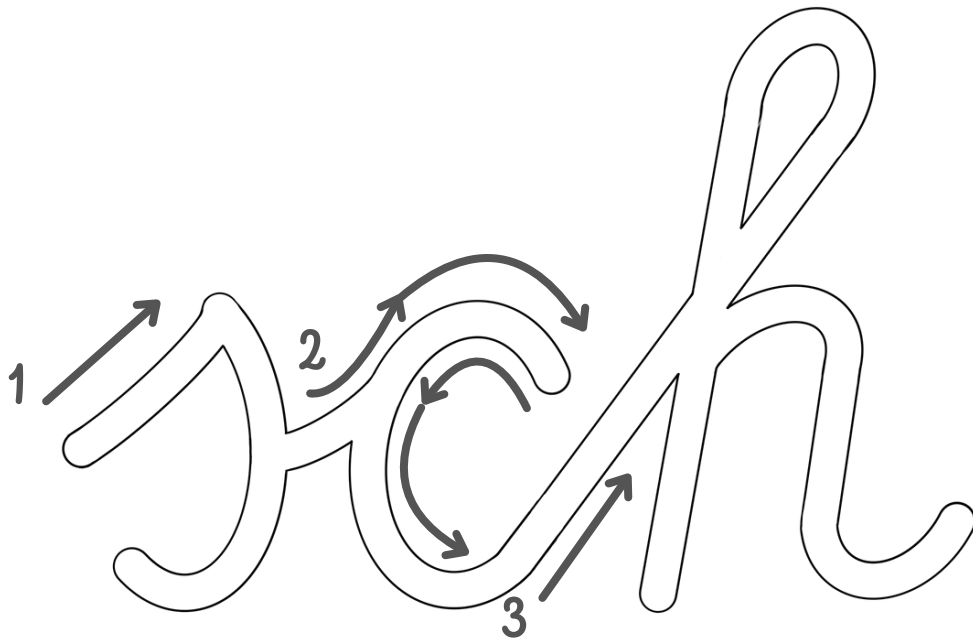

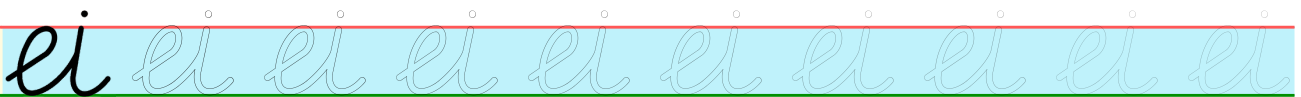
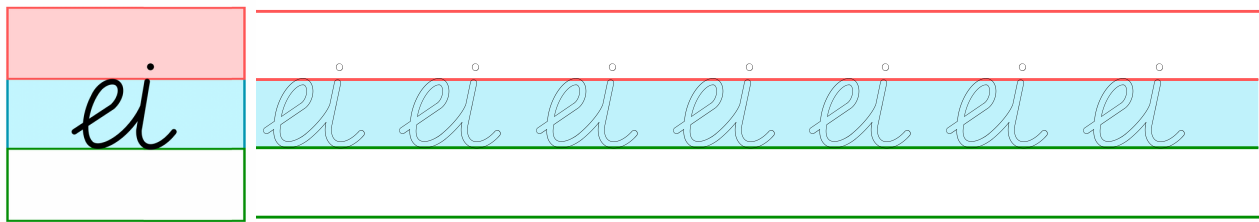
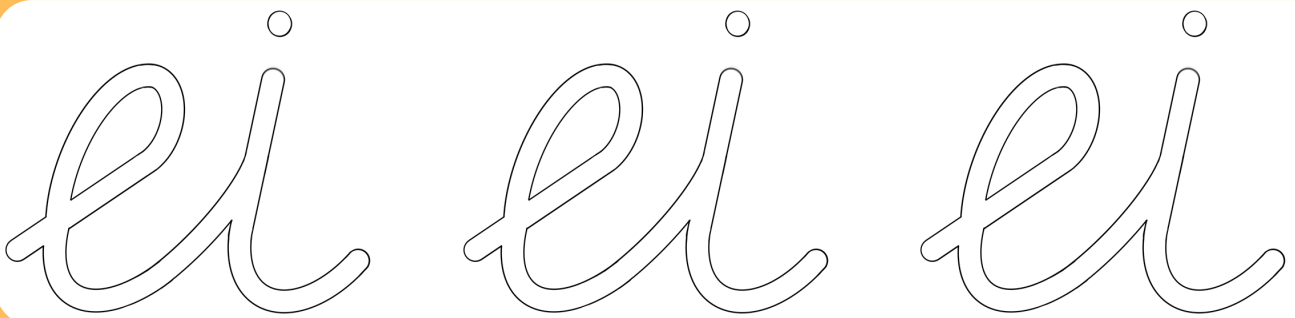
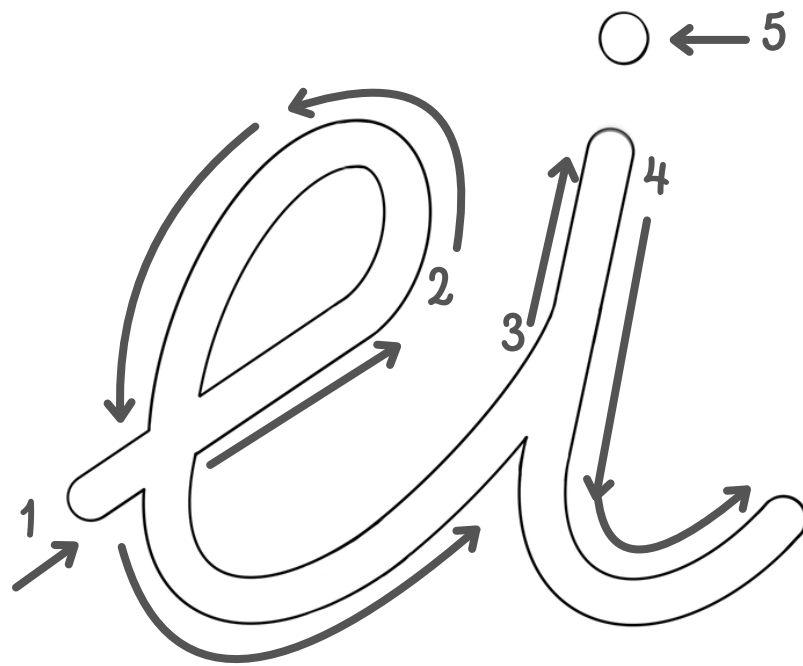

ei

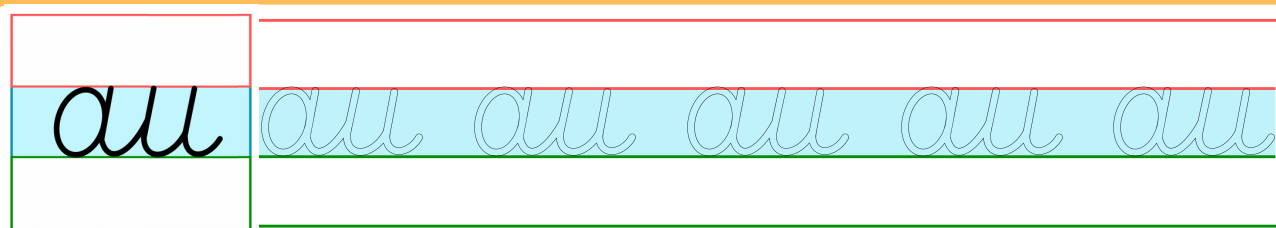
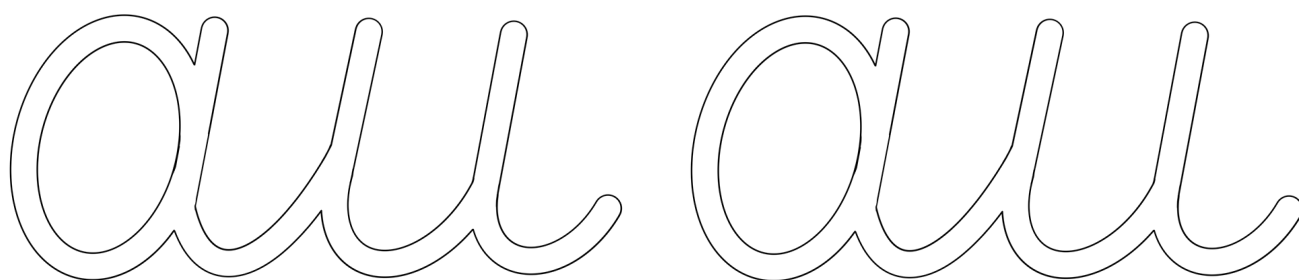
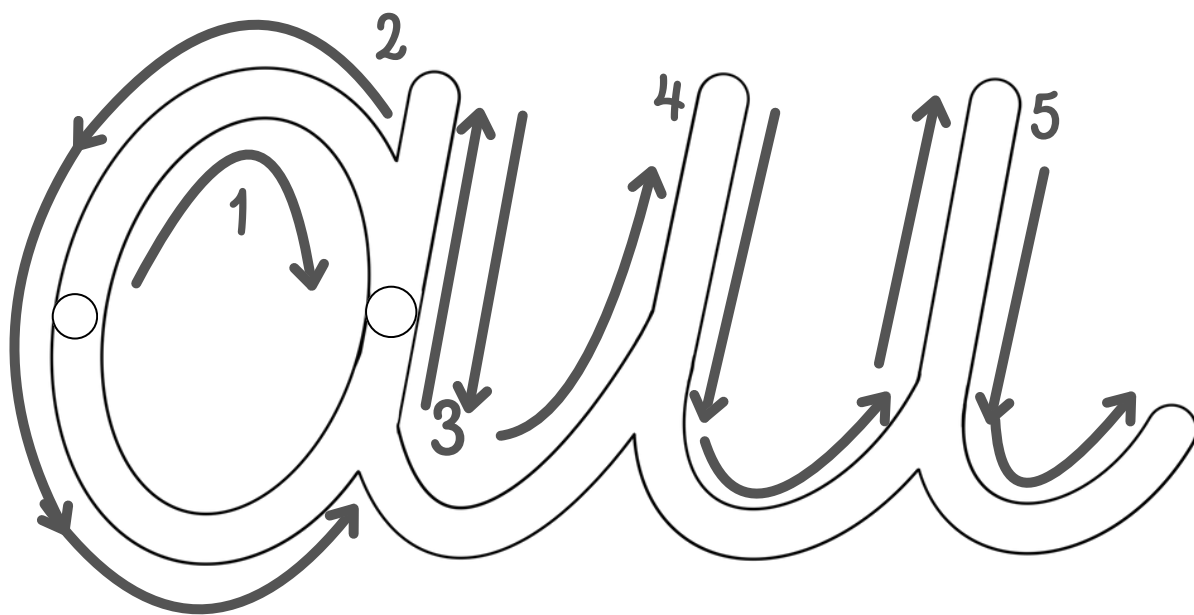

*a*

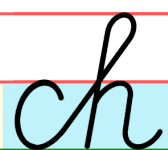
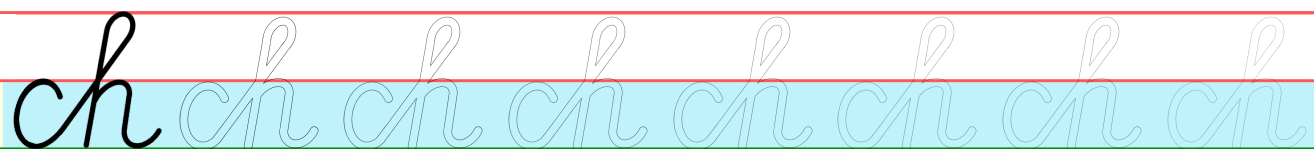
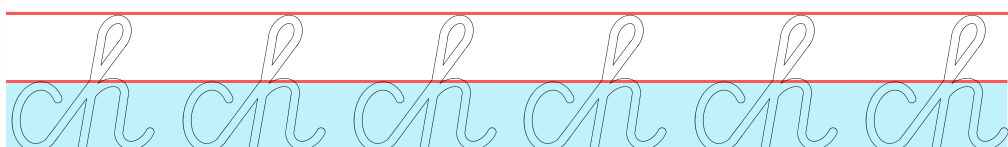
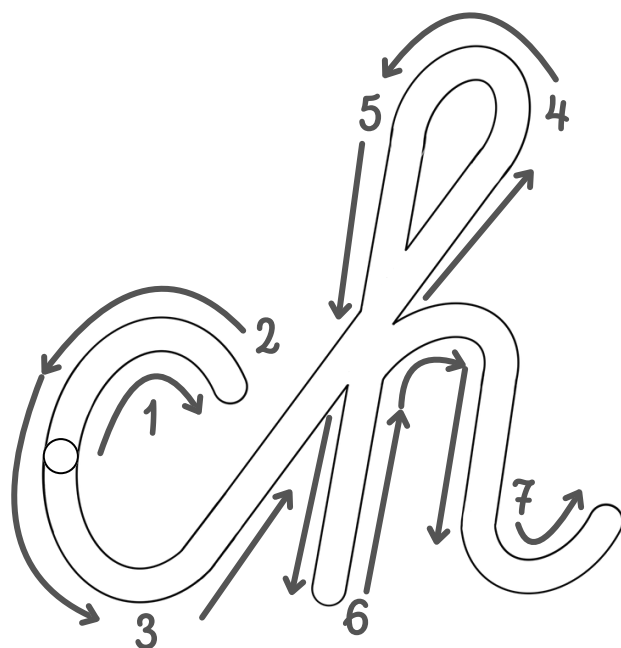

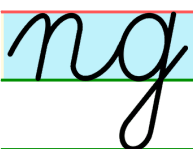
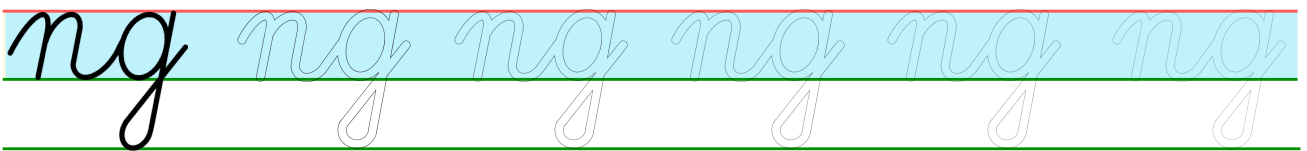
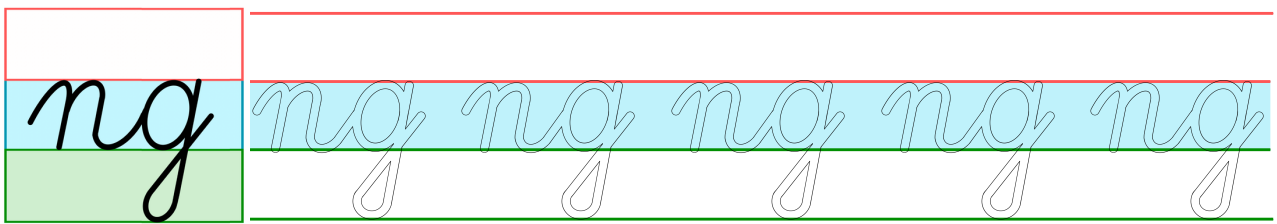
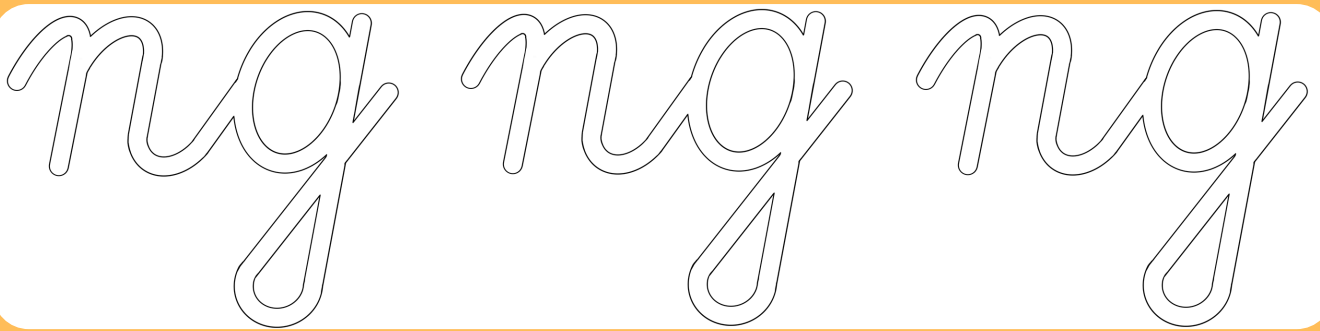
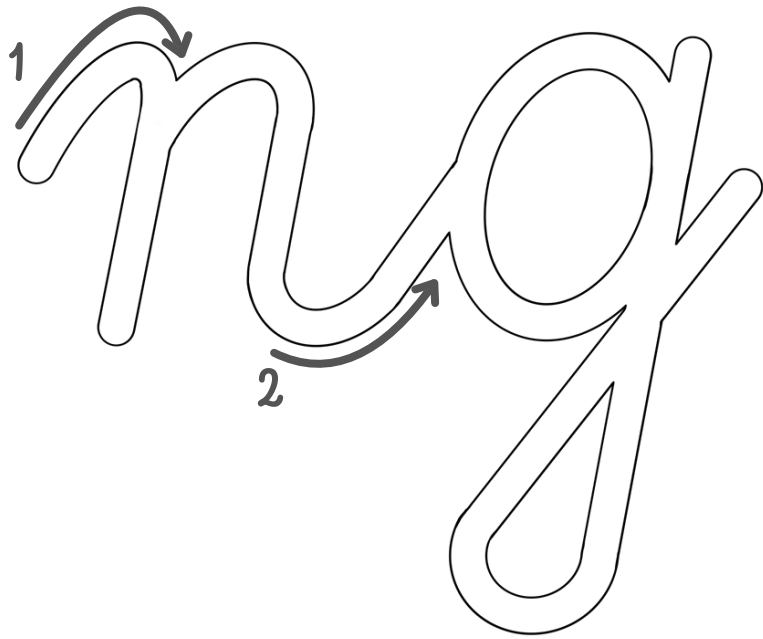

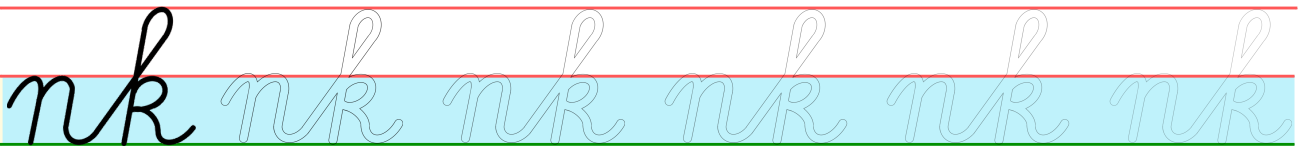
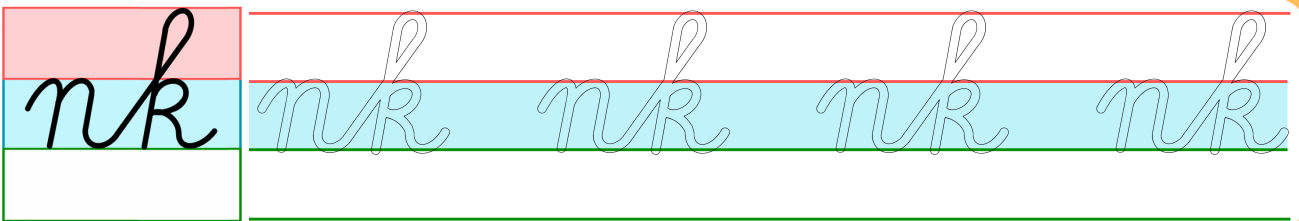
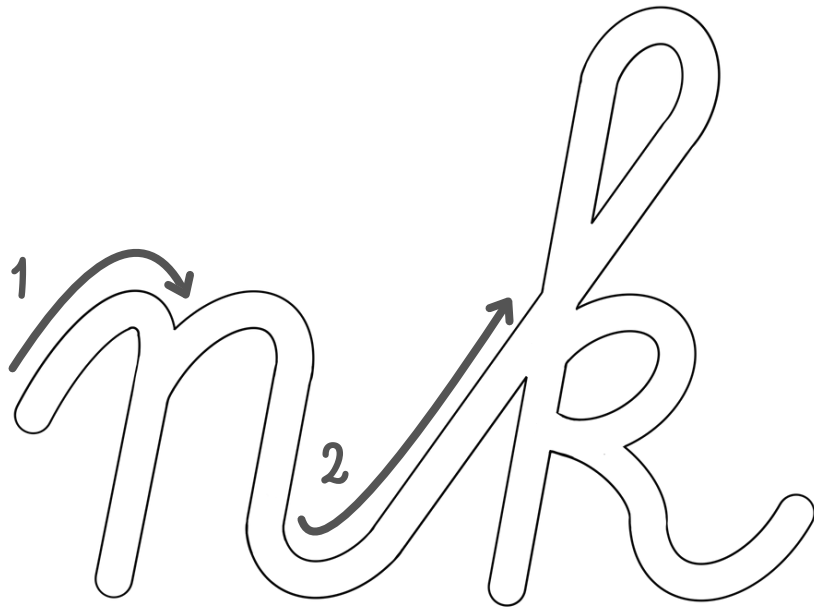

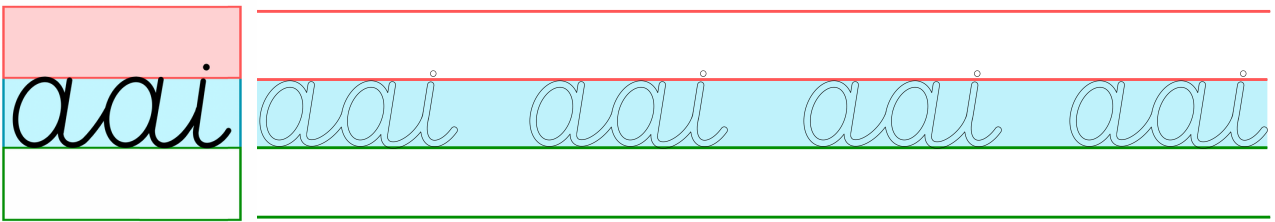
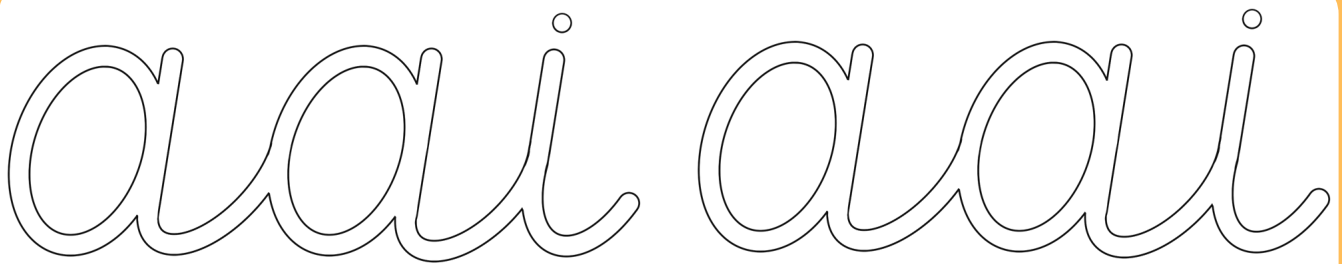
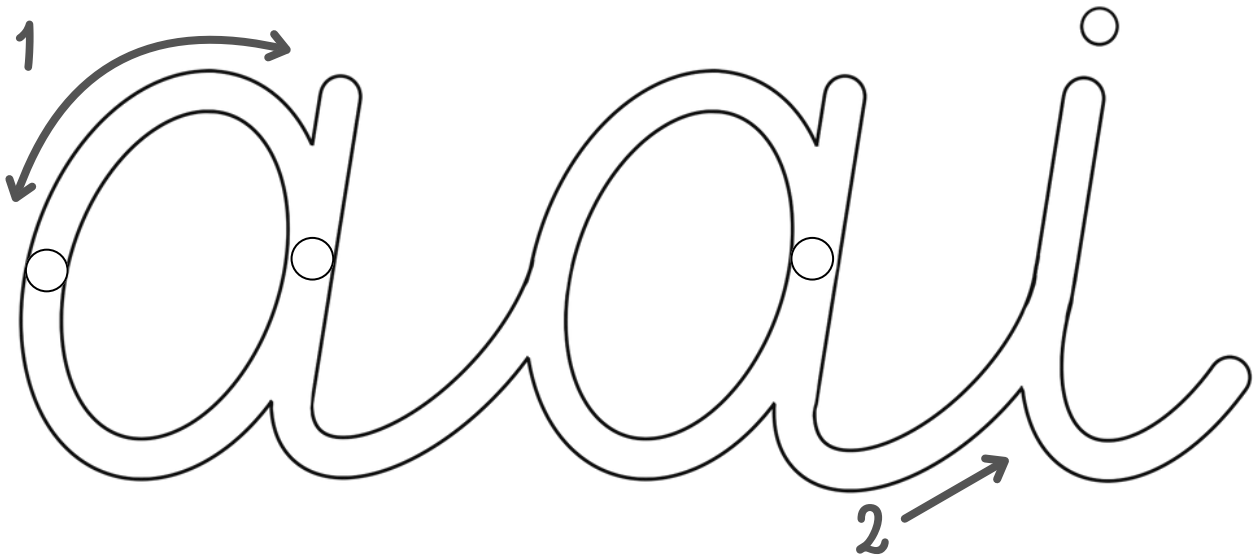

dadi

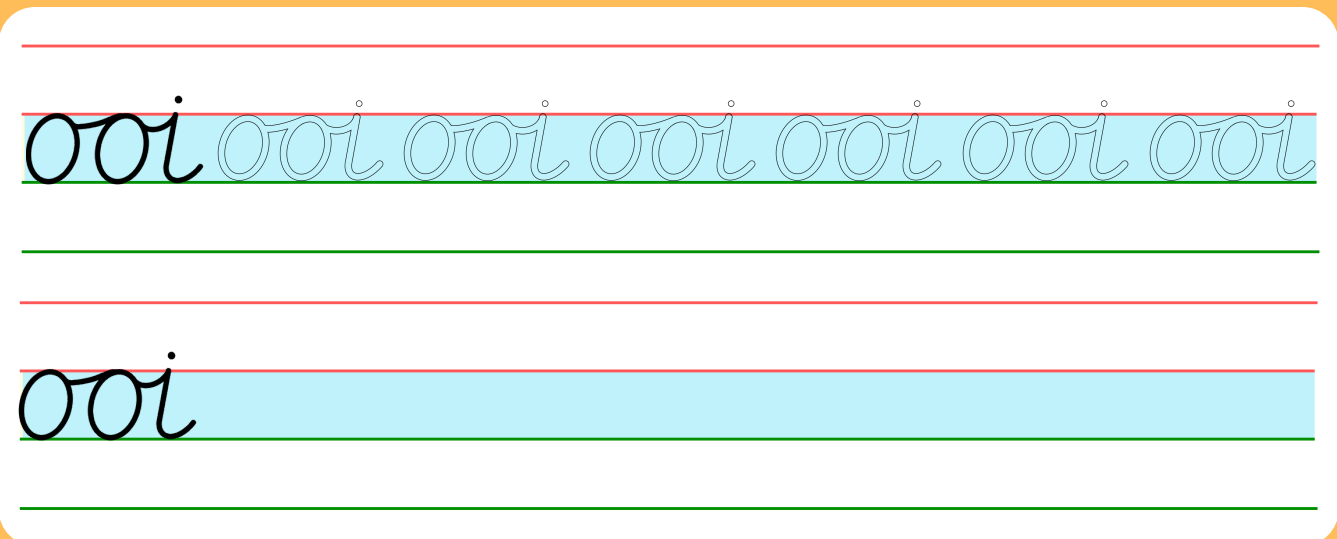
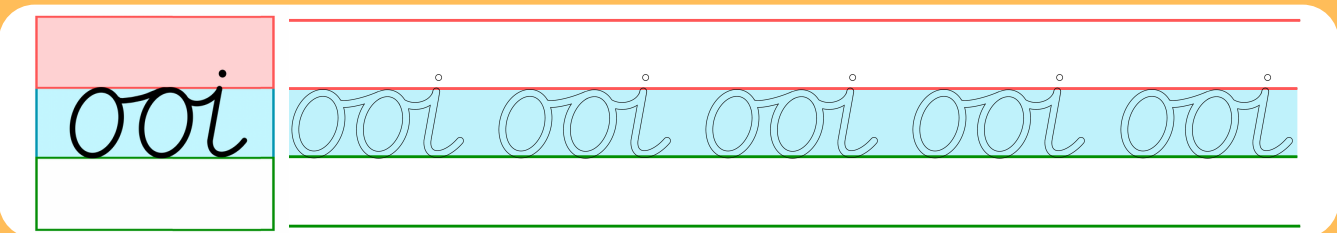
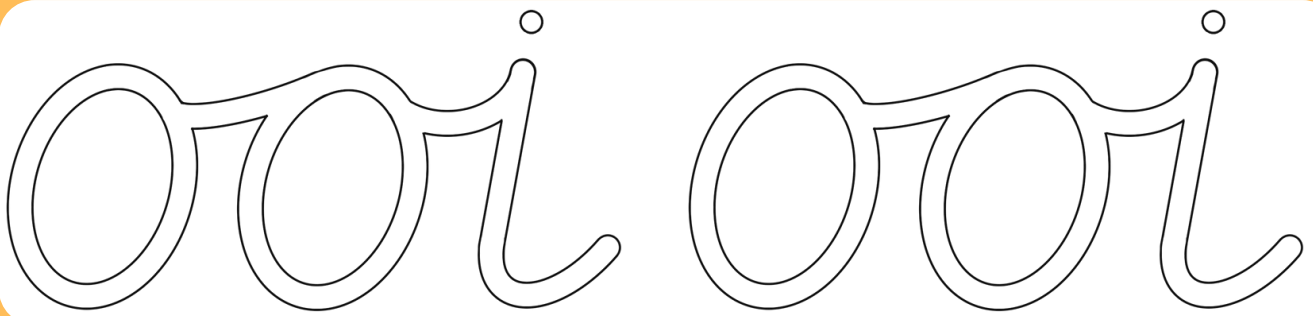
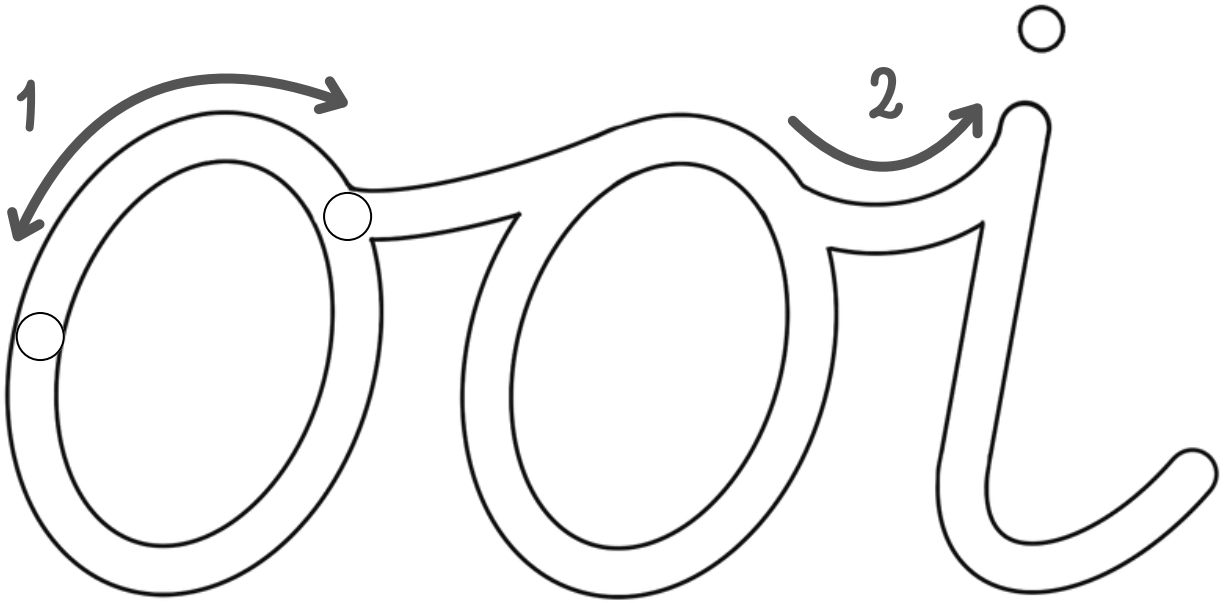



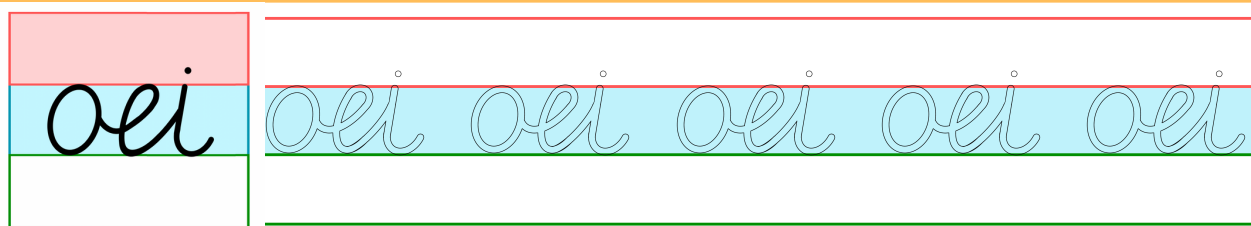
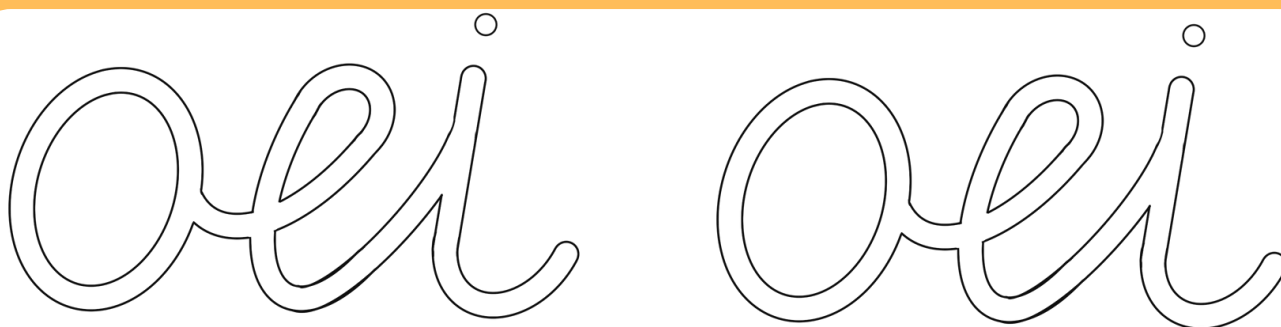
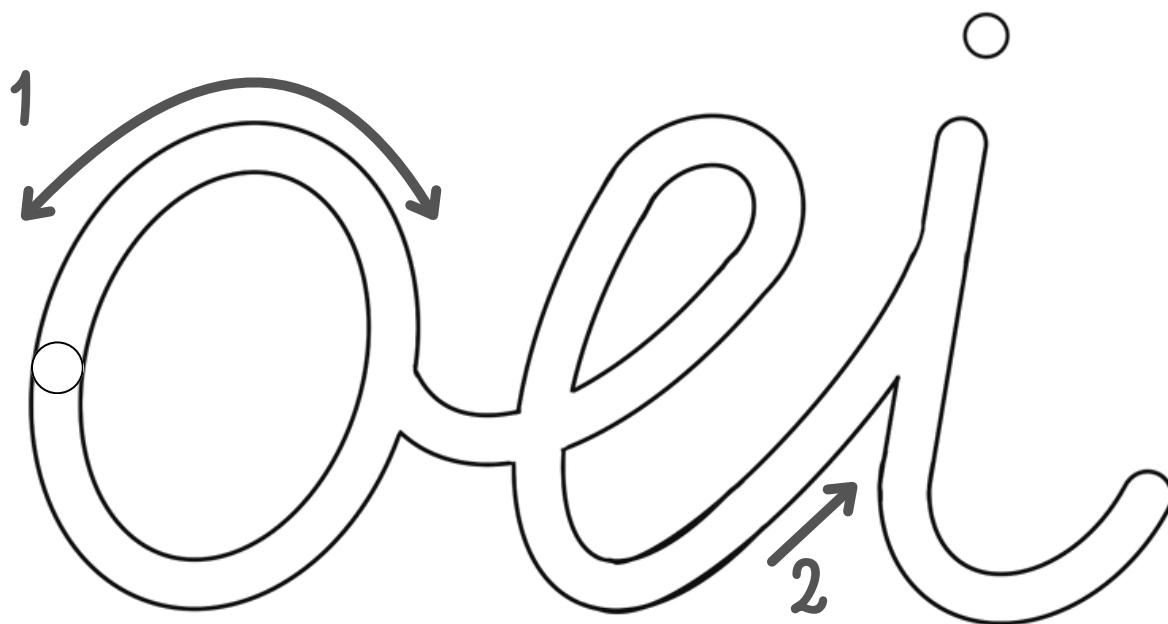

oei

