

i	k
---	---

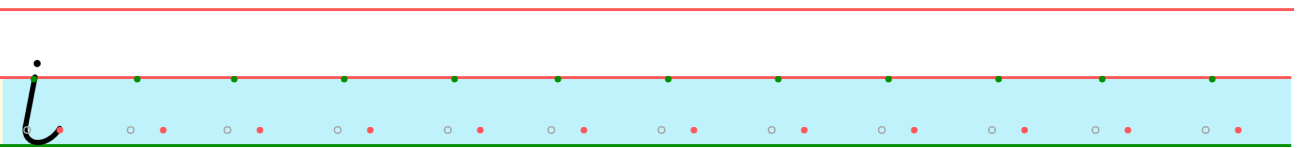

i	k
---	---

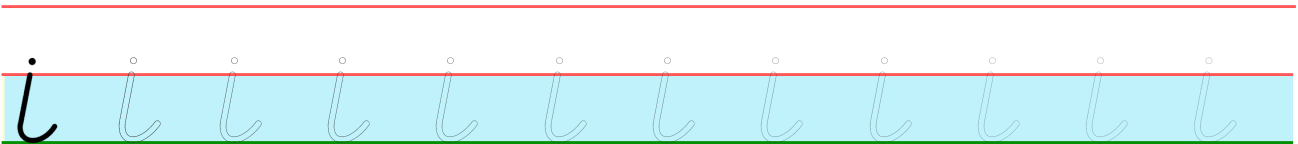
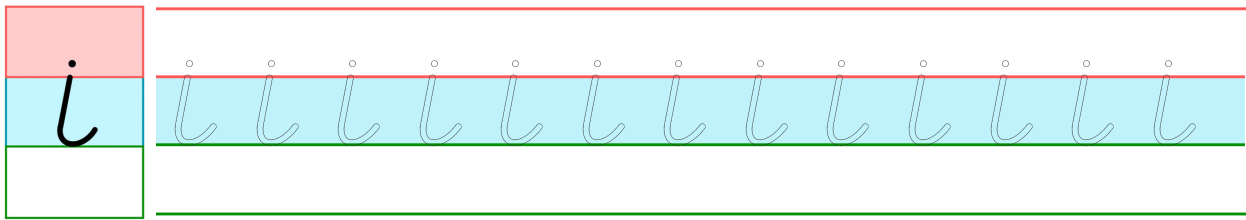
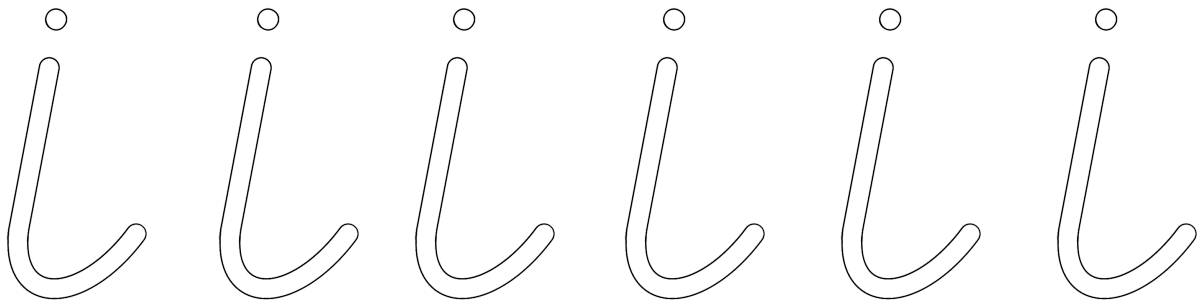
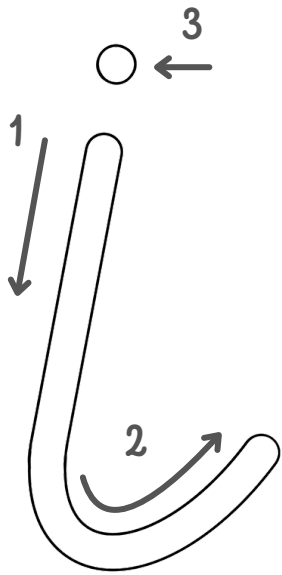
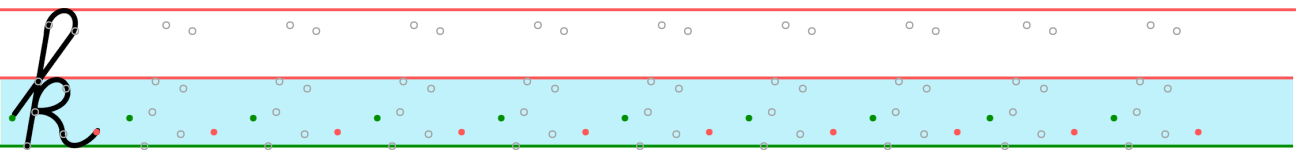
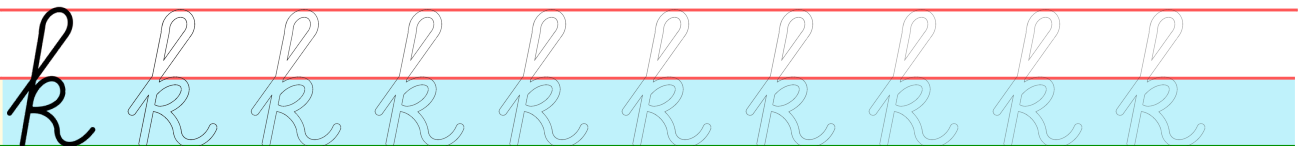
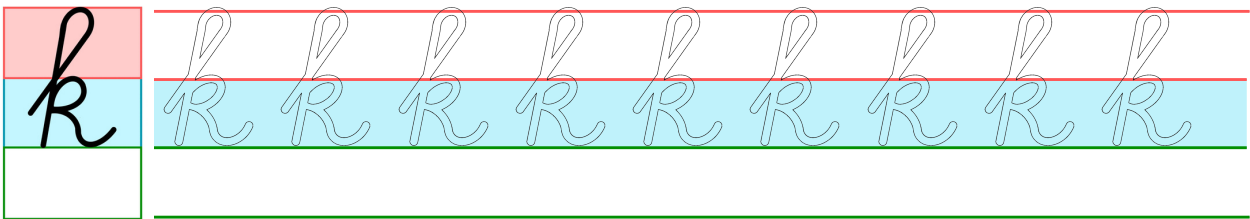
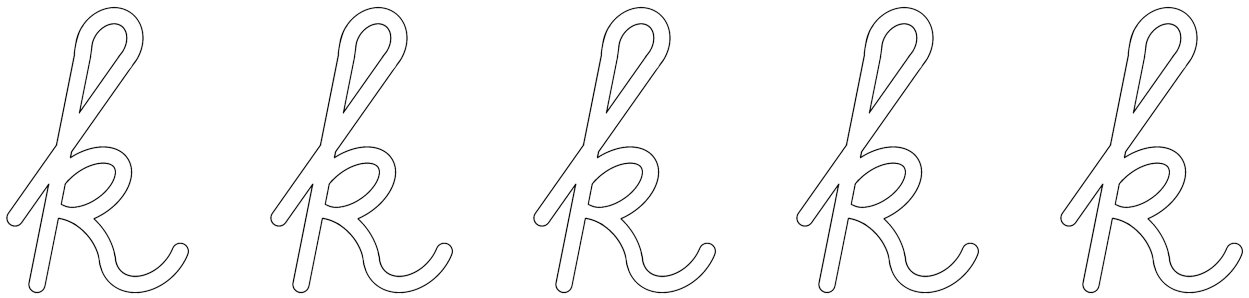
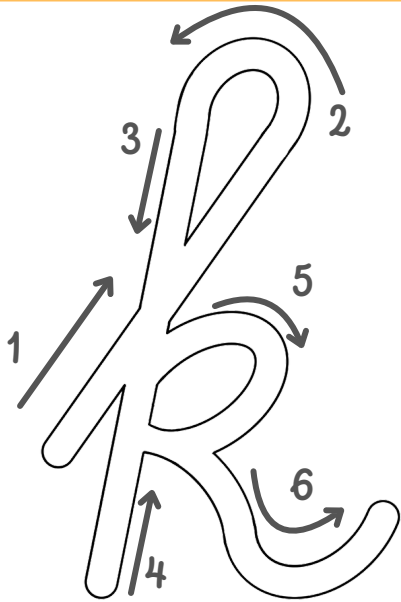

a	n
---	---

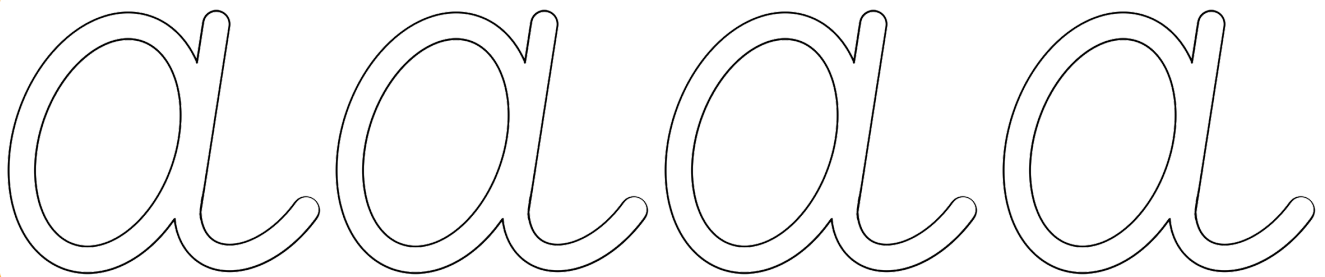
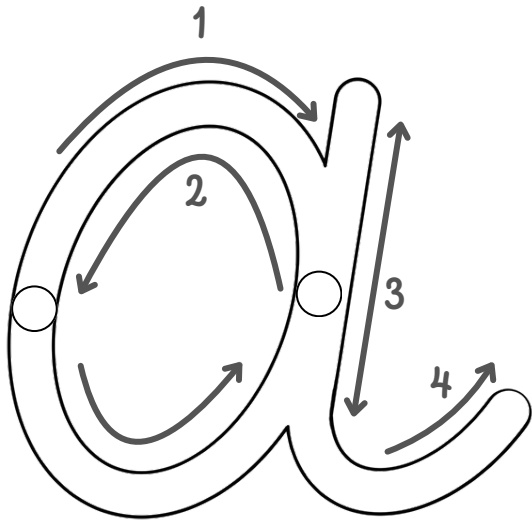

a



a

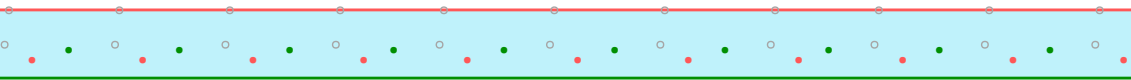

a	n
---	---

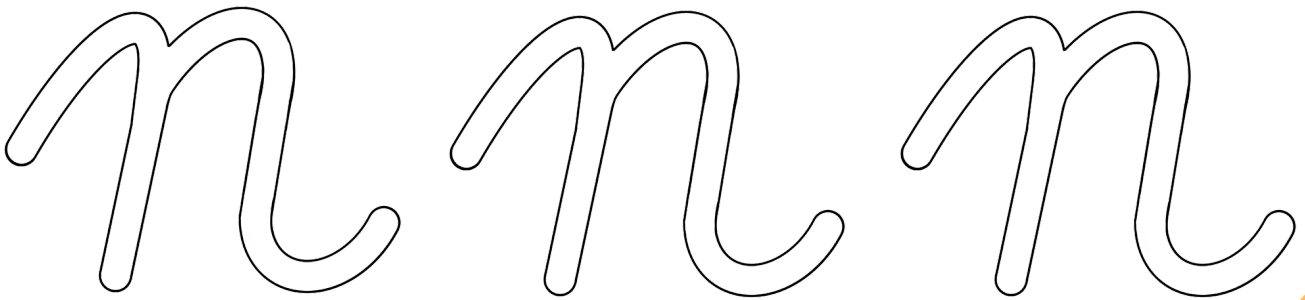
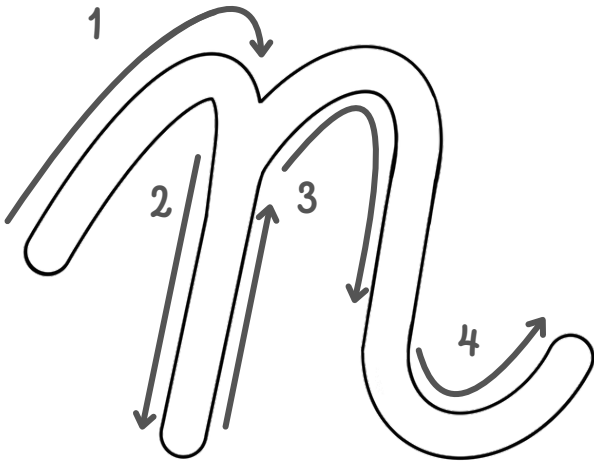

n

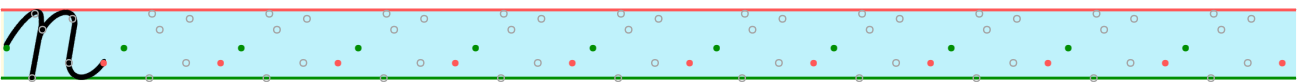
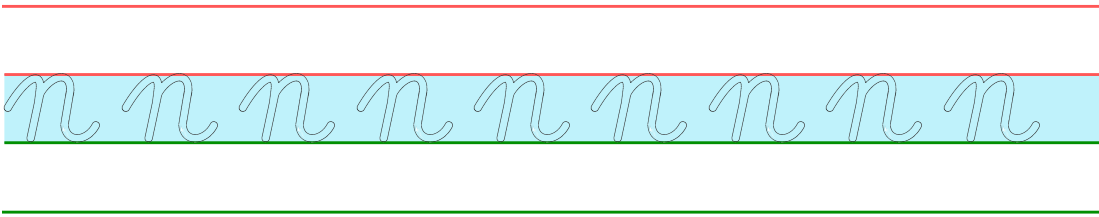

e	l
---	---

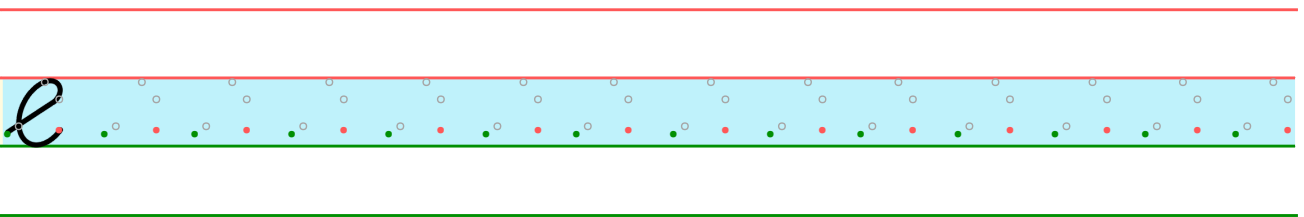
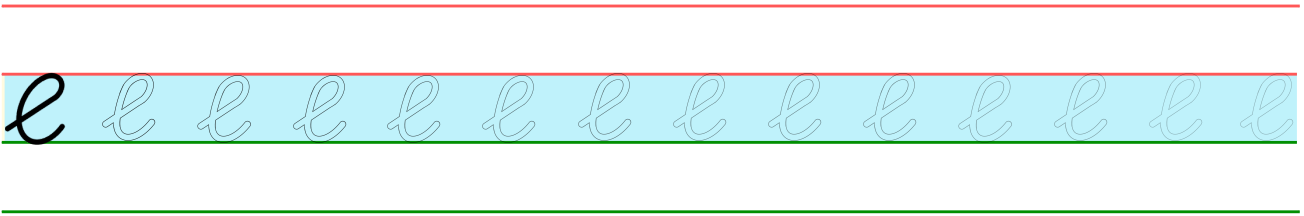
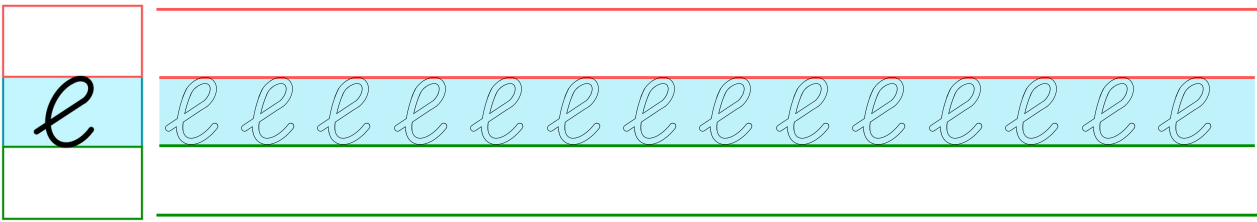
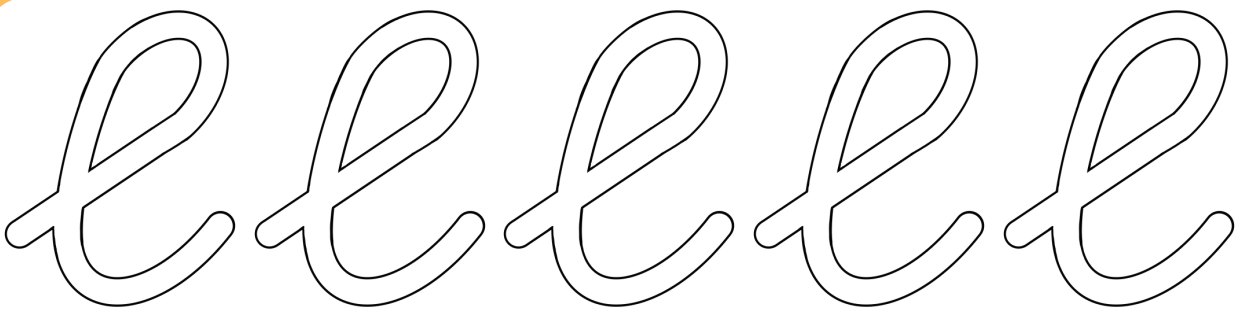
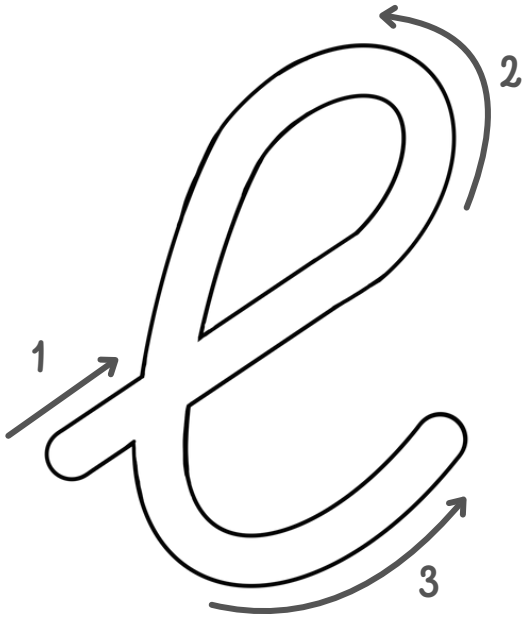

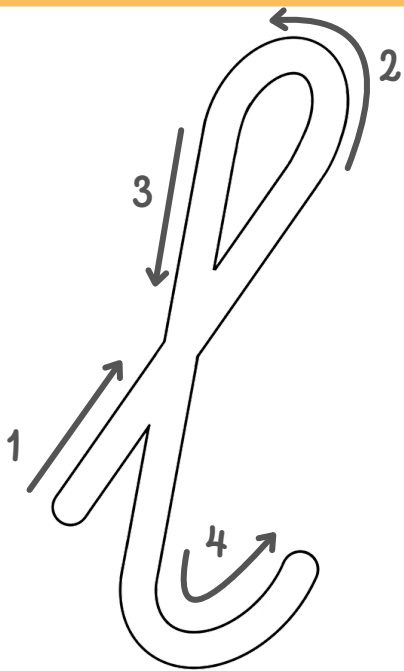

e	l
---	---

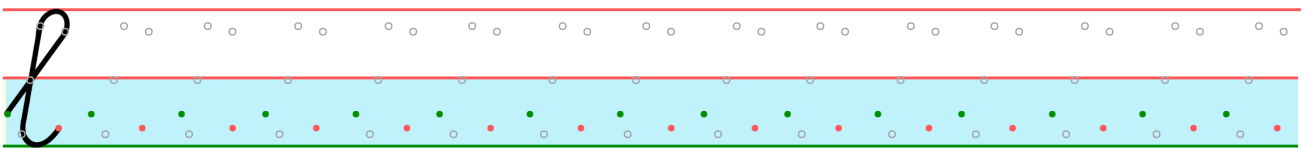
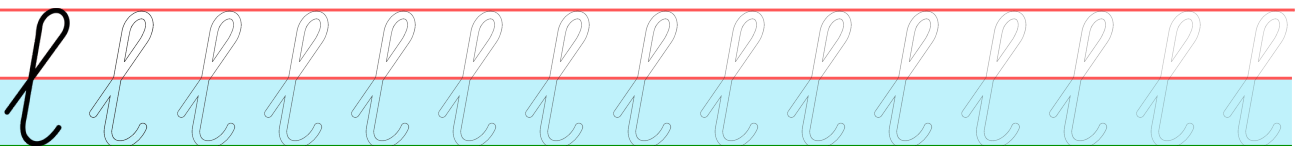
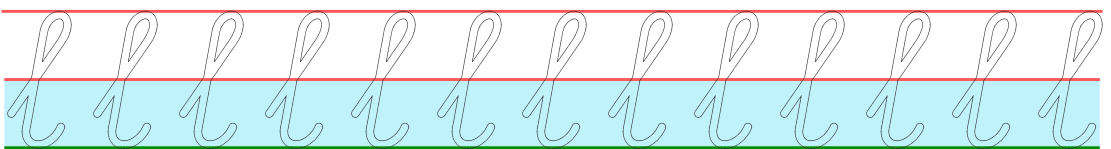
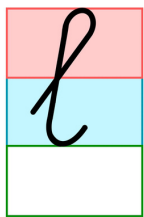
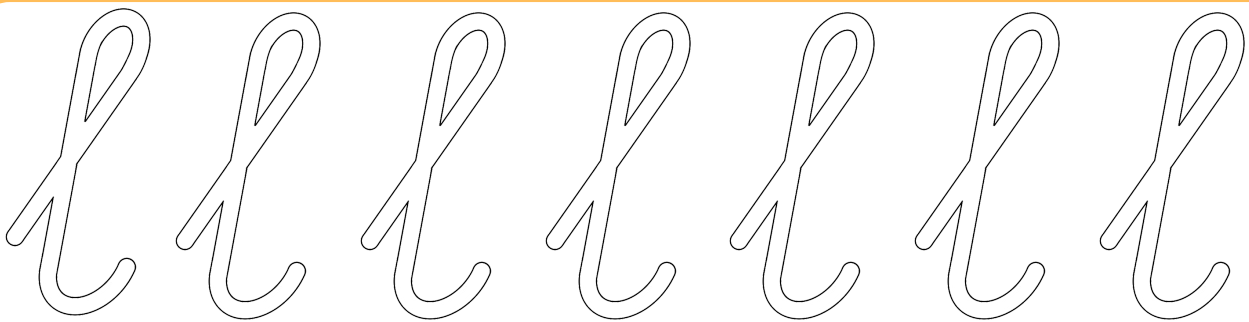

ee t

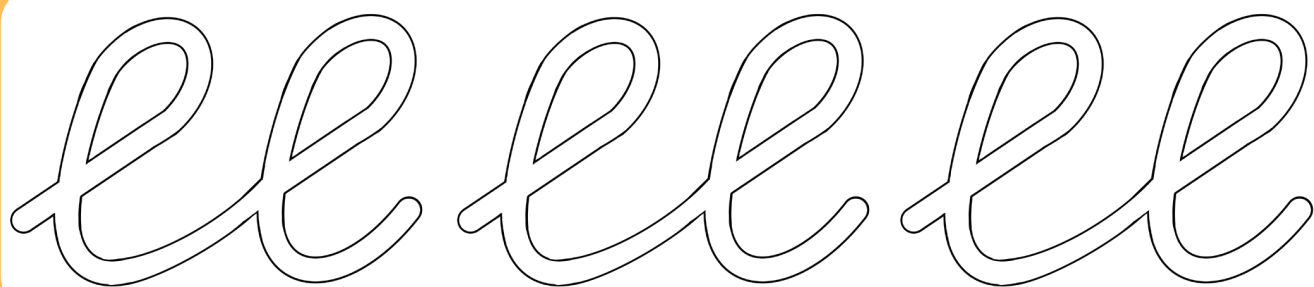
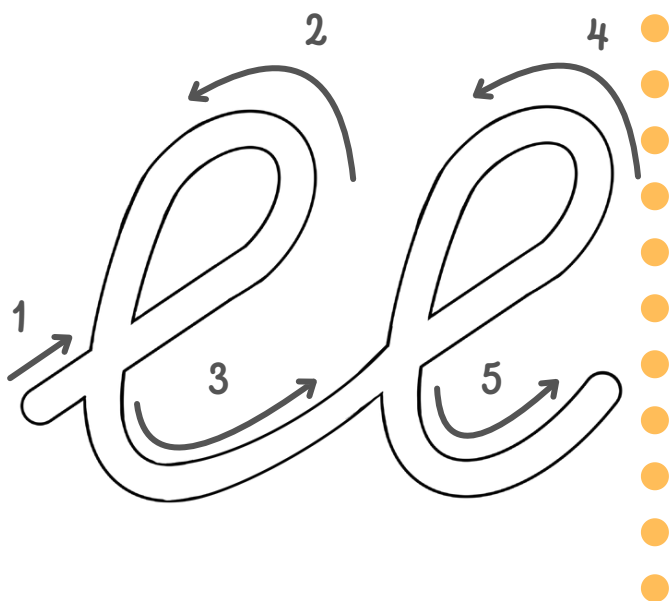

ee

ee ee ee ee ee ee ee ee

ee ee ee ee ee ee ee ee ee ee

ee

ee

t

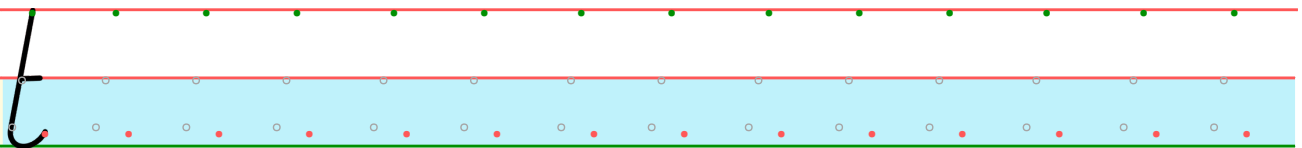
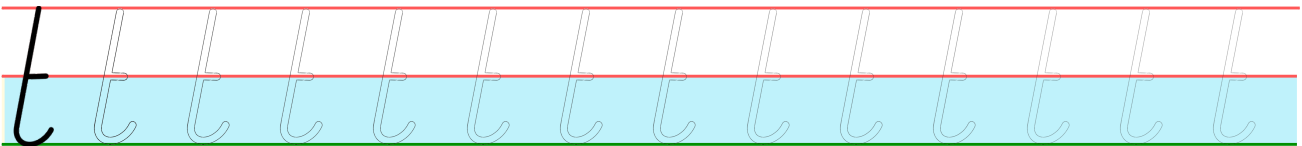
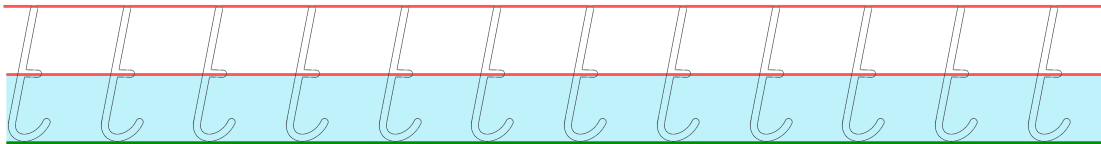
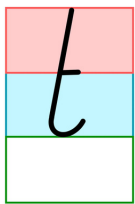
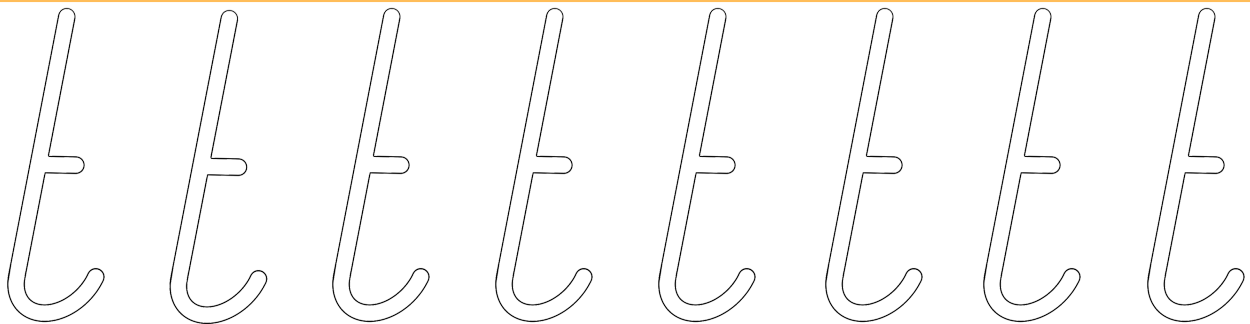
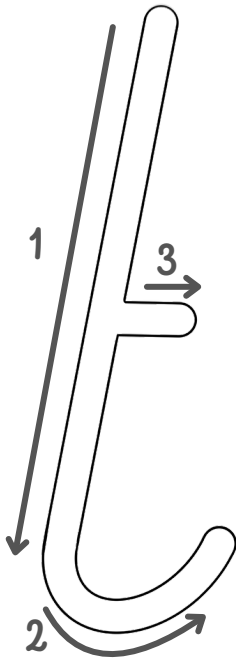

aa

p

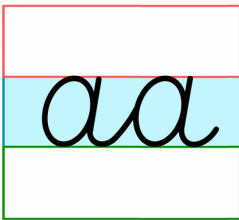
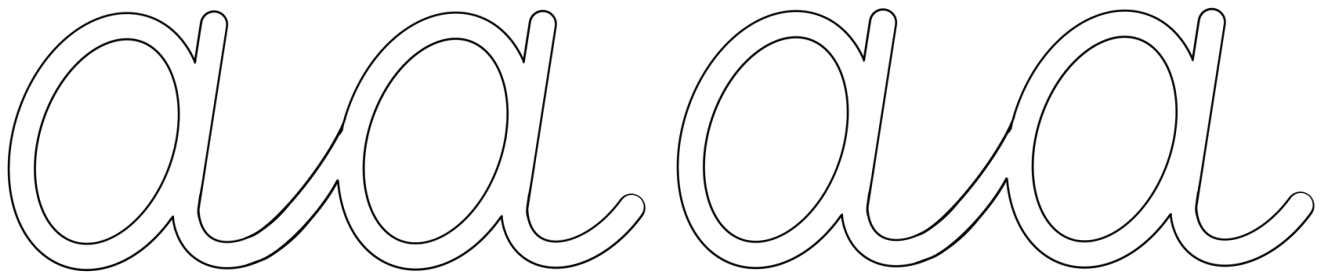
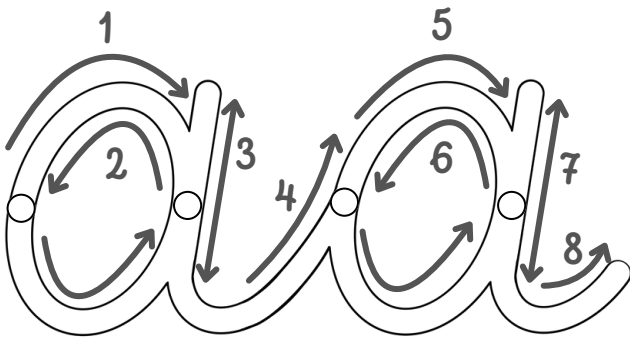

aa p

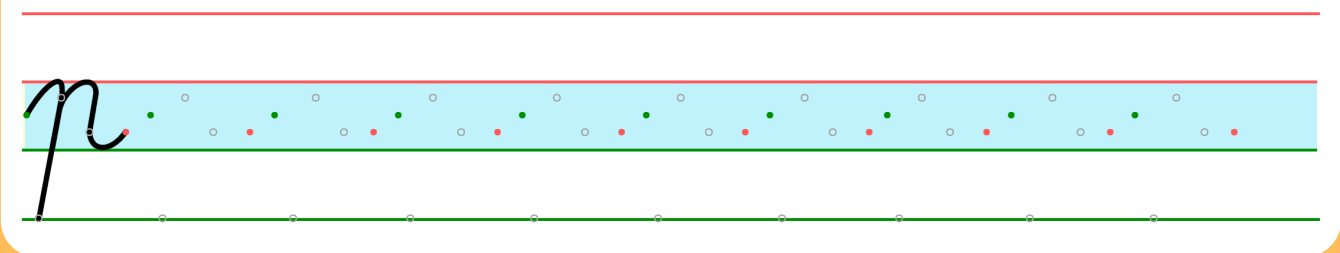
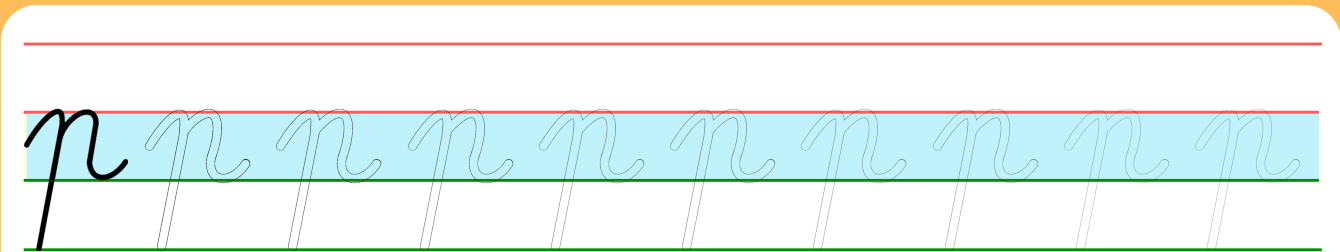
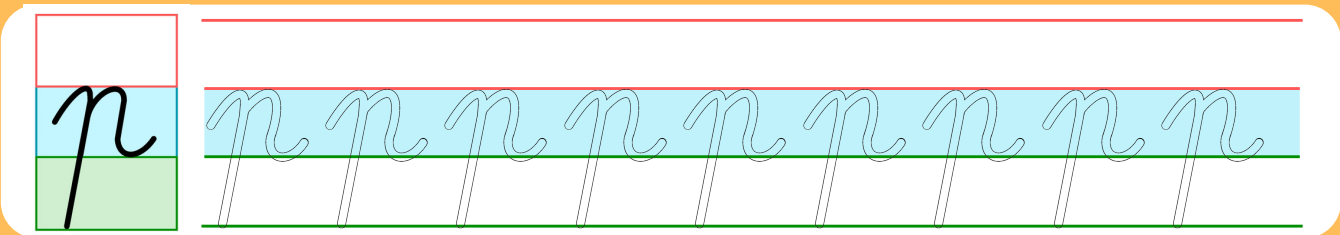
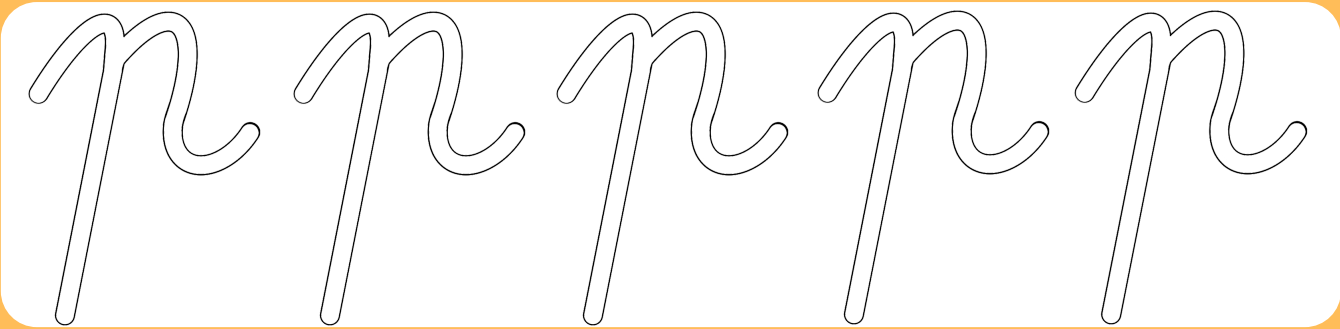
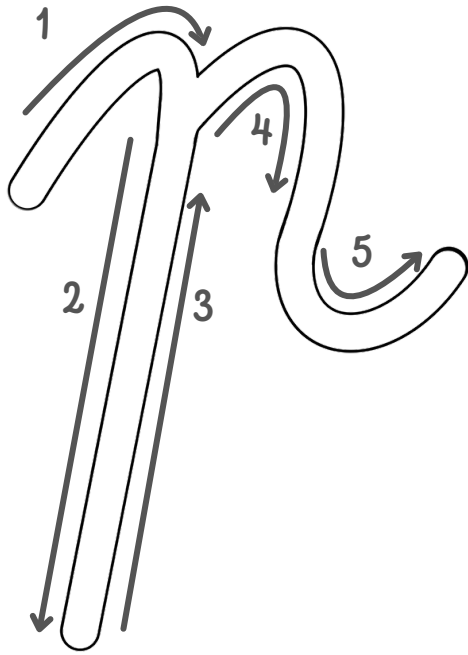

ij	s
----	---

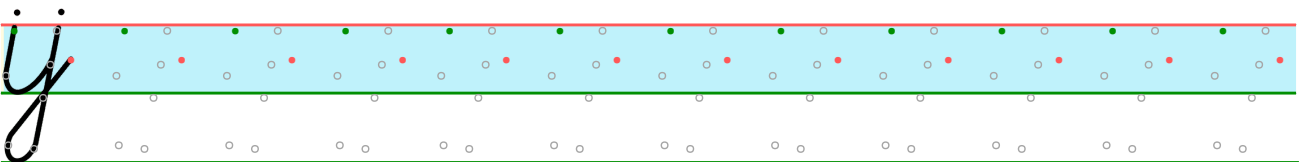
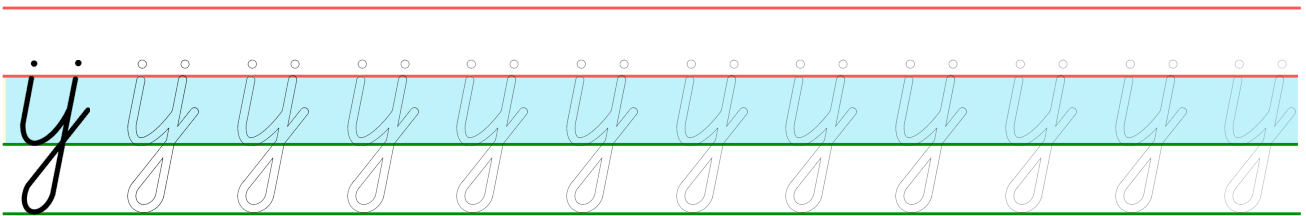
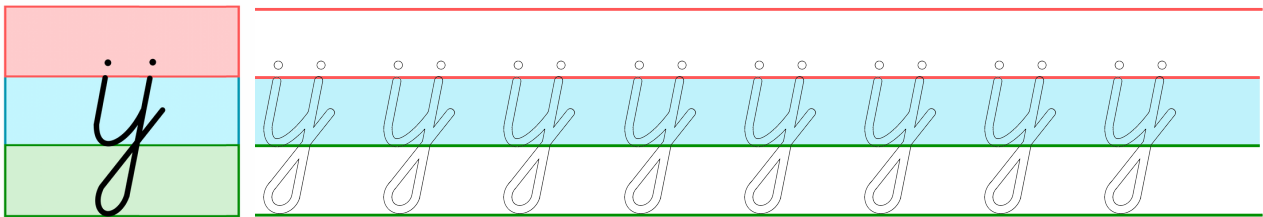
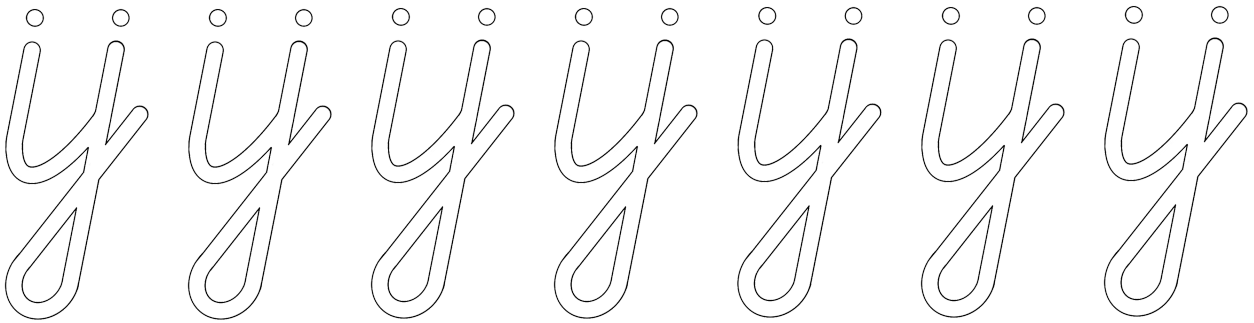
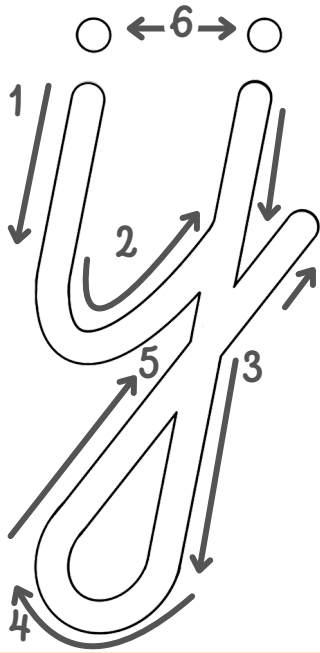

ij

s

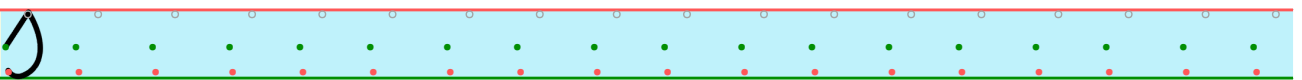
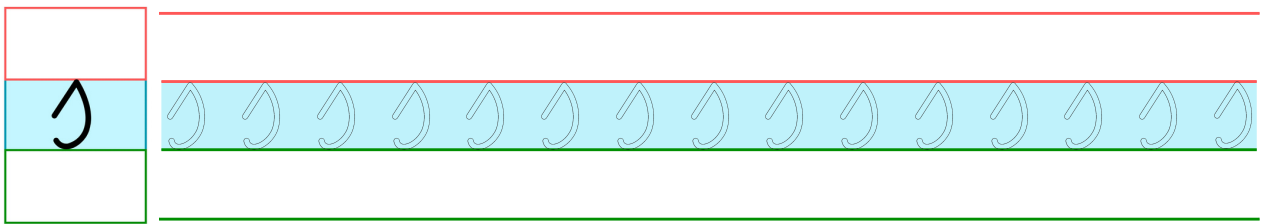
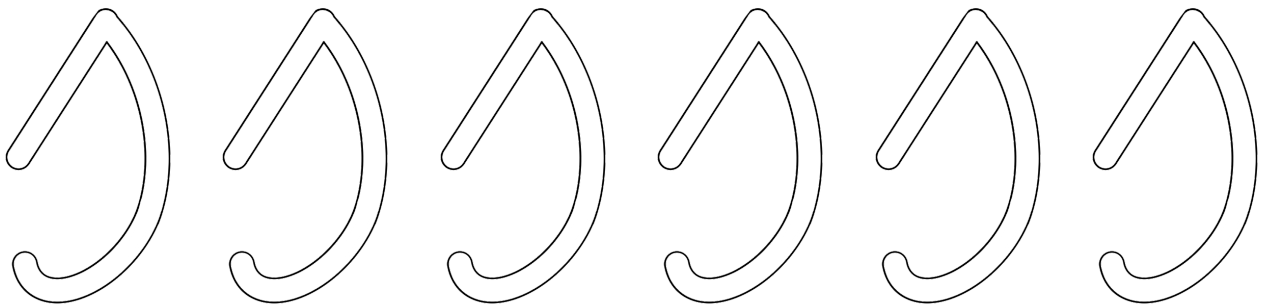
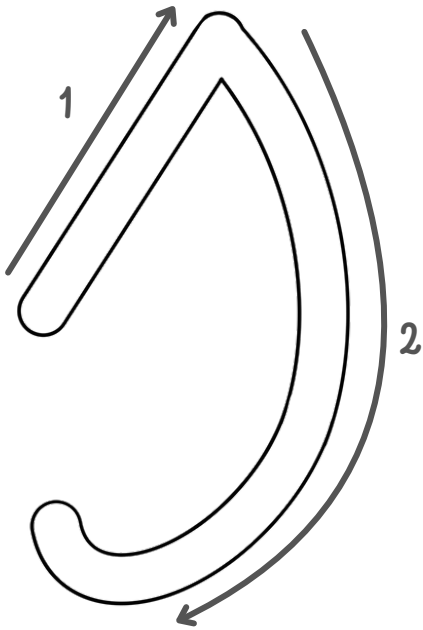

o	m
---	---

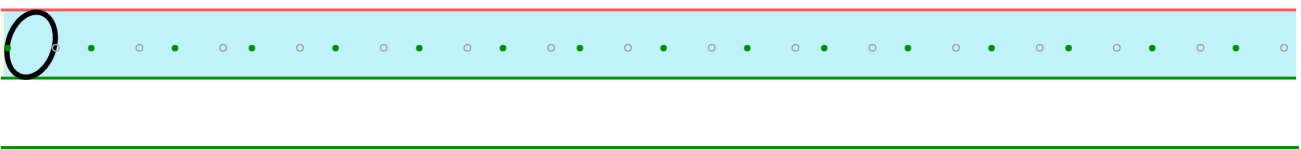
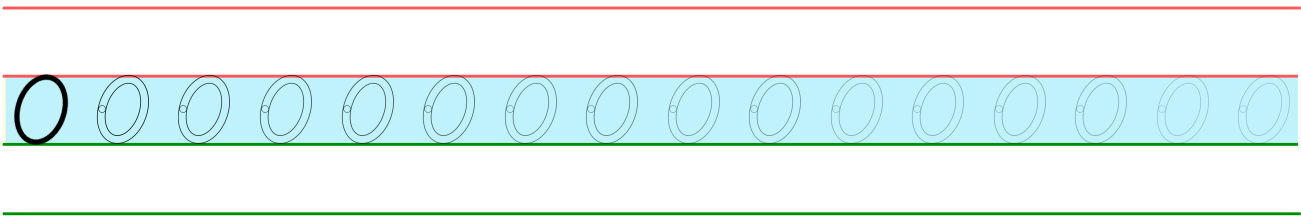
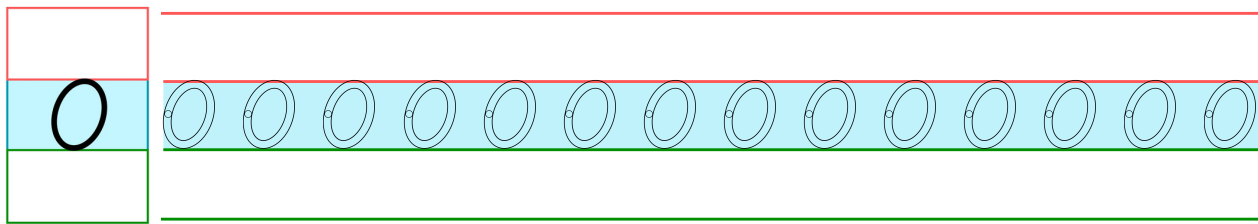
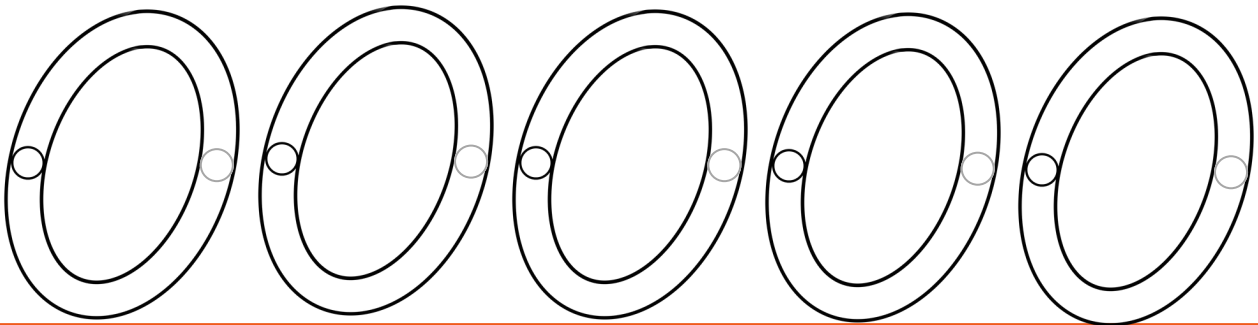
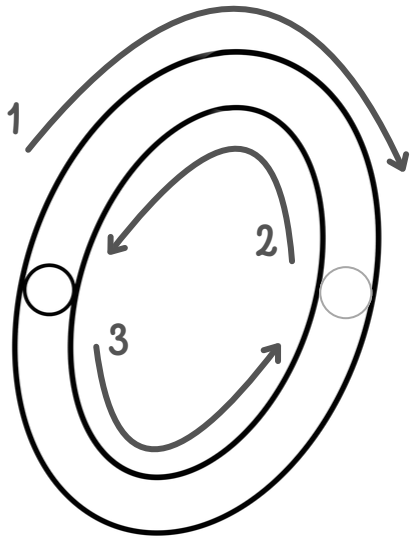

o	m
---	---

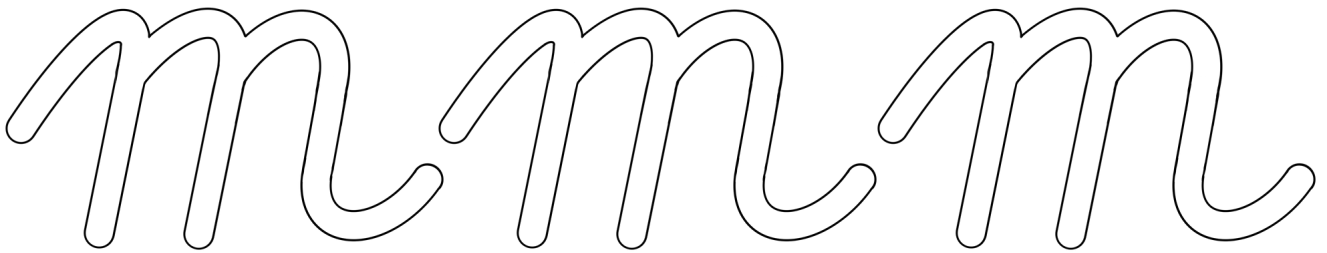
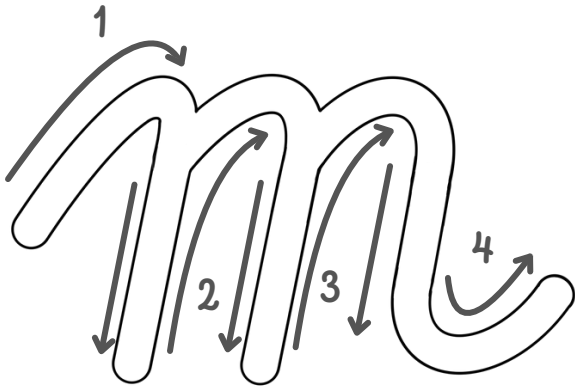

m



m



m

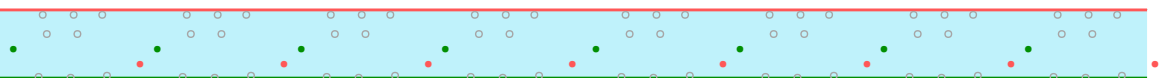

ui

l

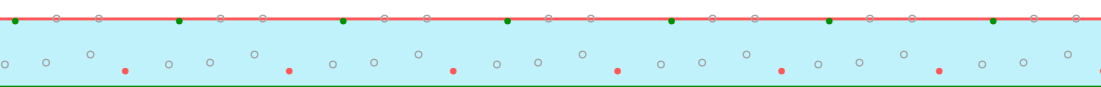
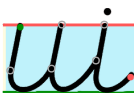
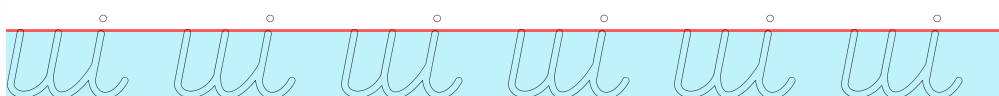
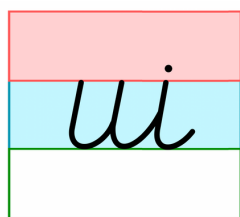
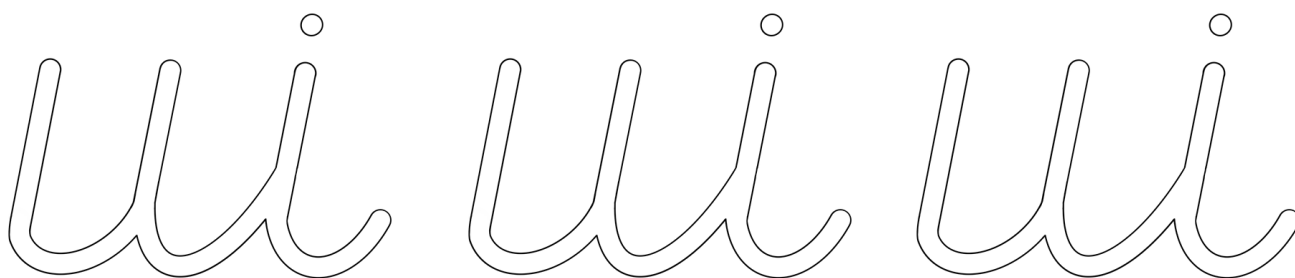
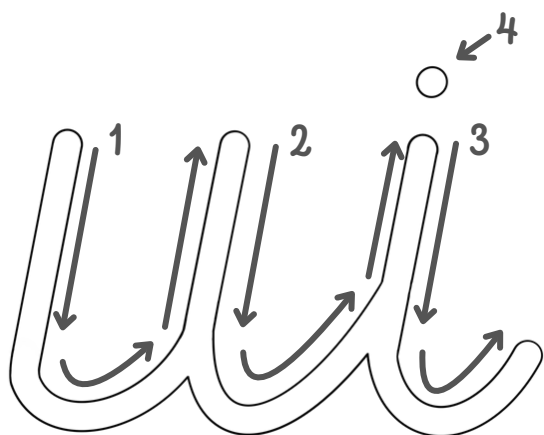

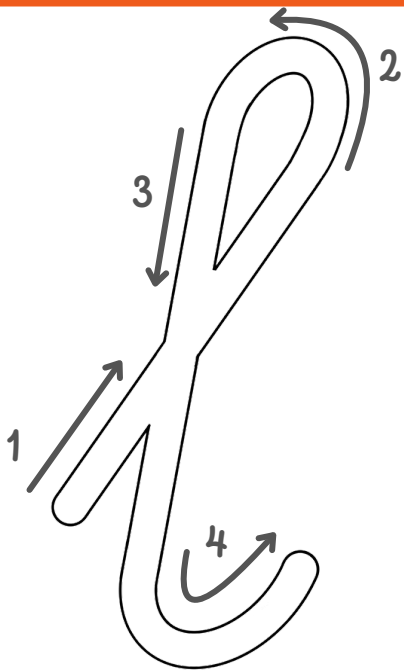

ui	l
----	---

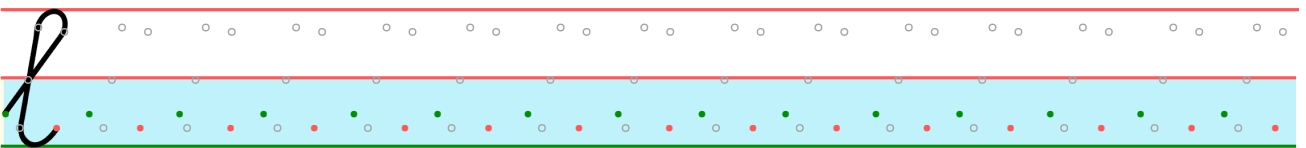
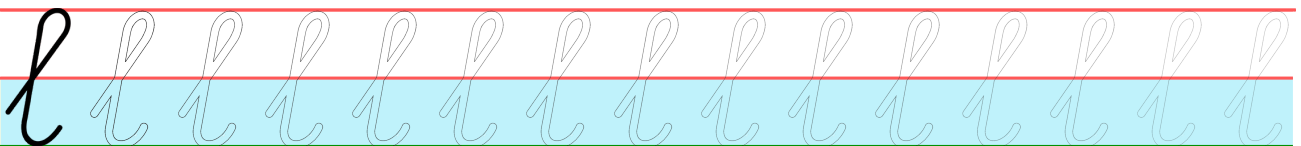
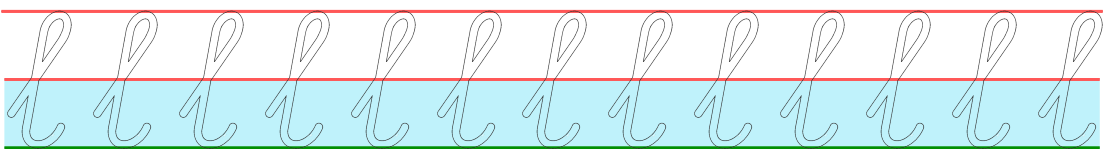
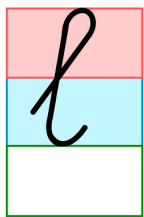
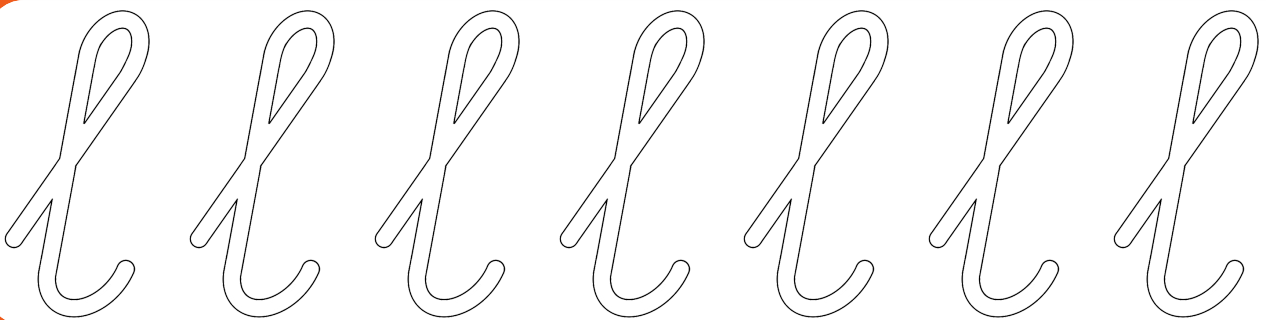

oo g

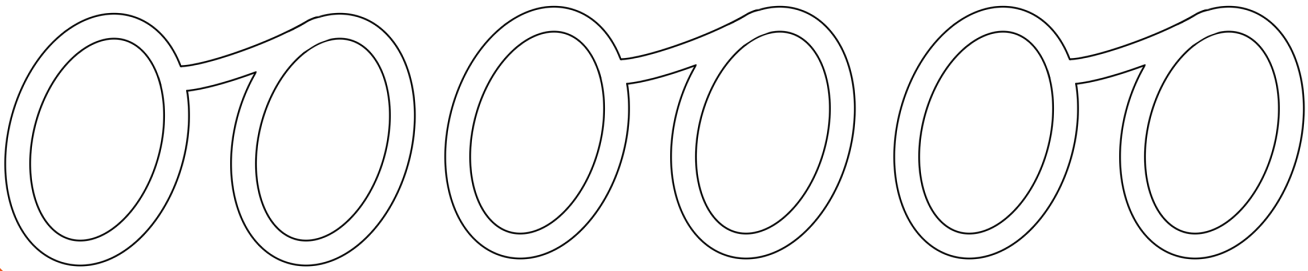
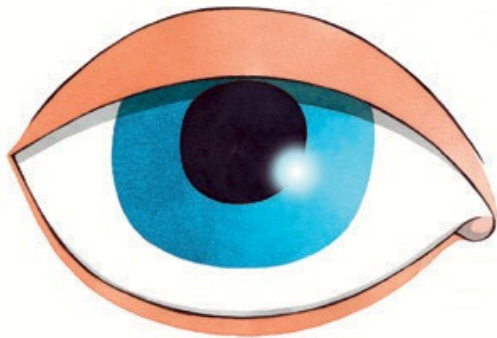
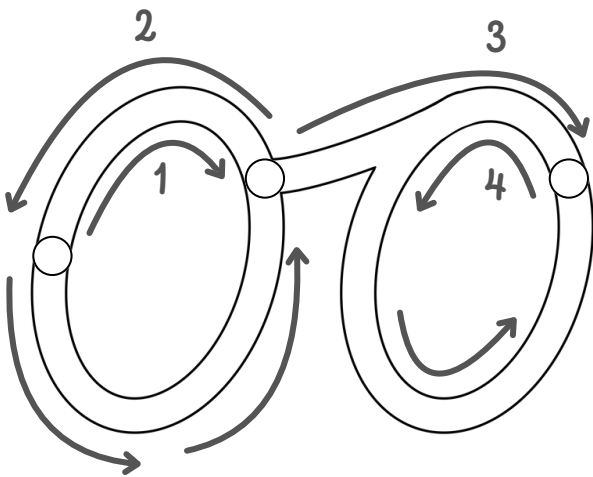

oo

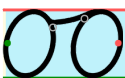

oo g

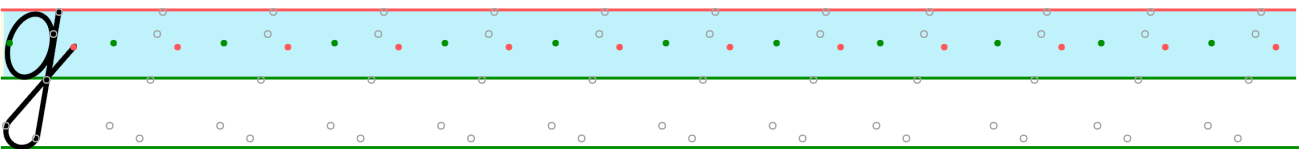
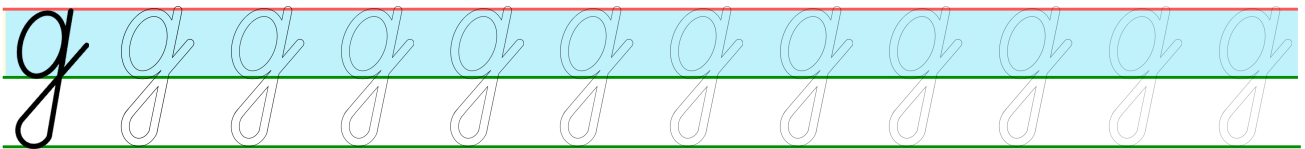
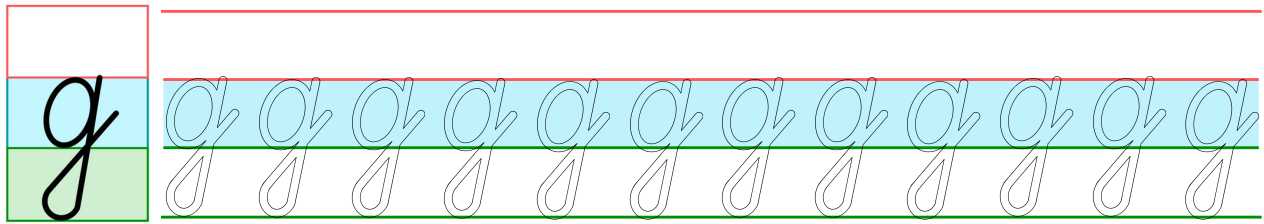
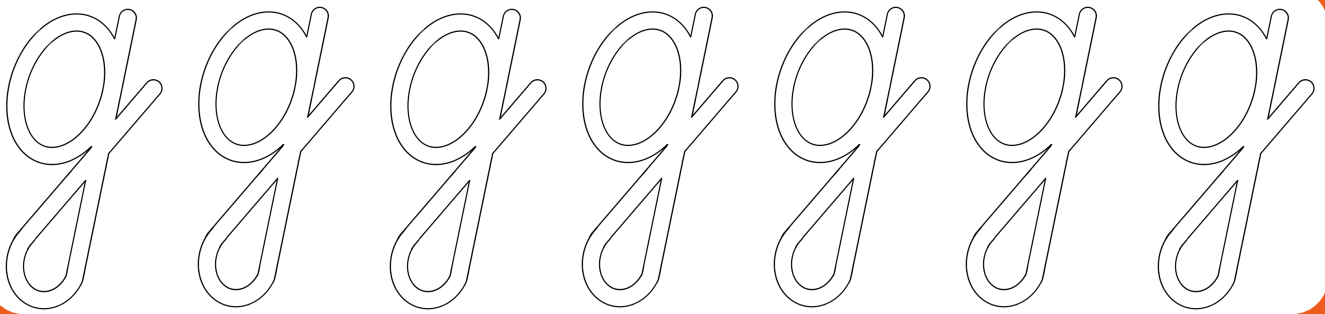
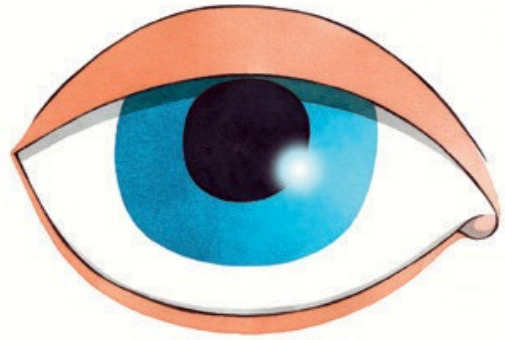
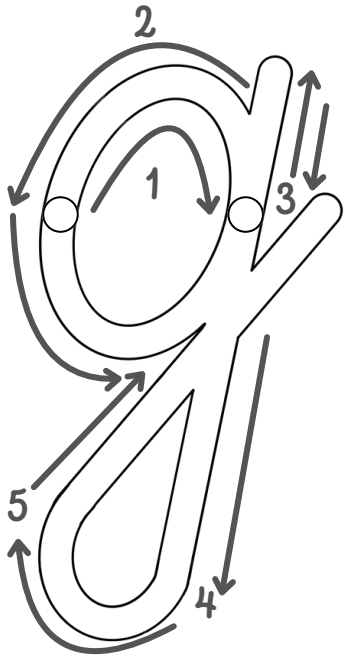

uu

r

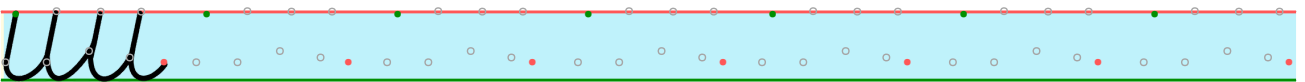
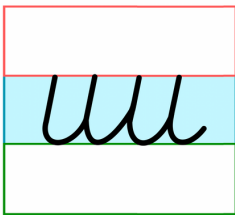
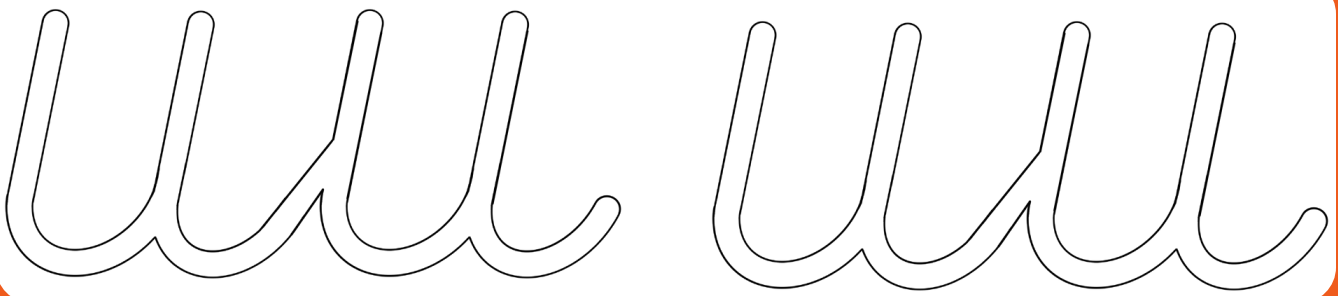
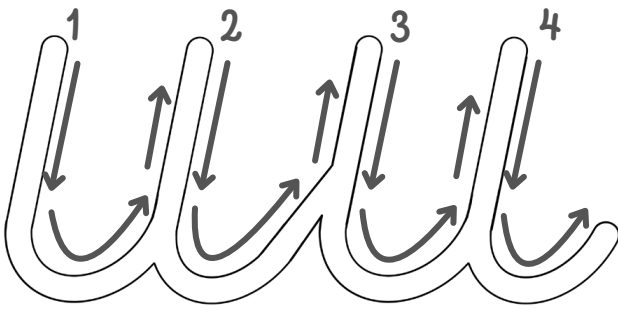

uu

r

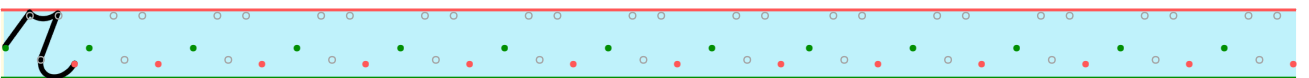
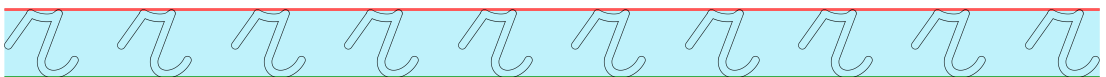
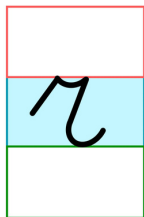
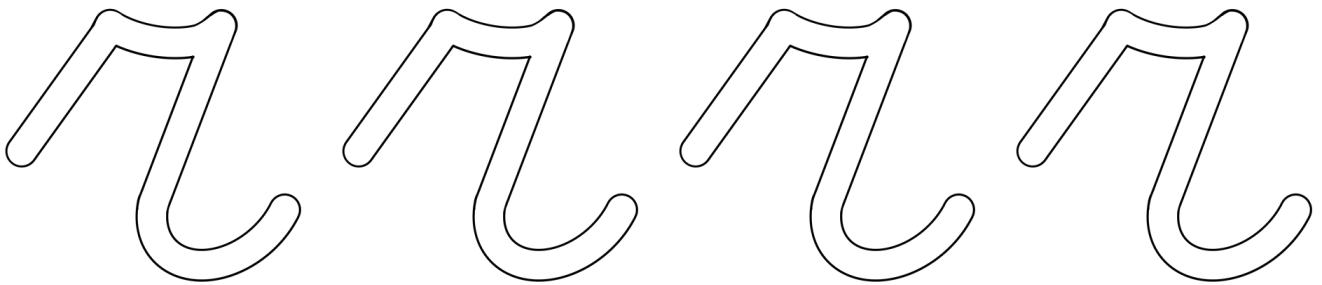
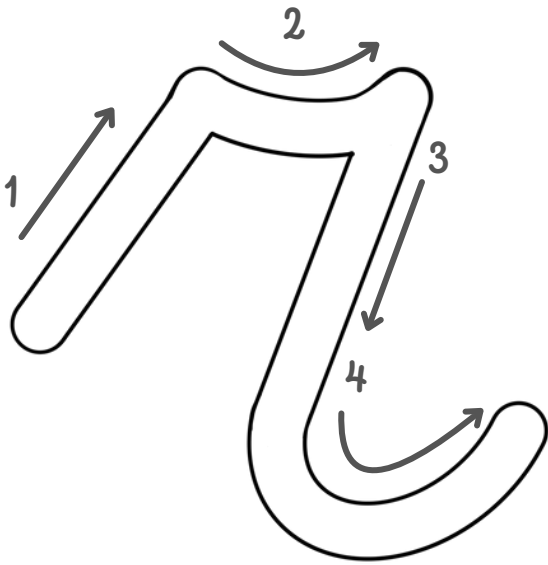

u k

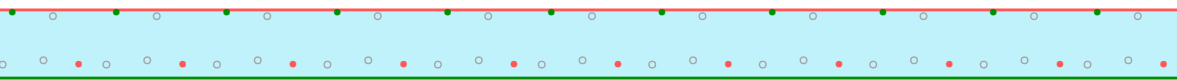
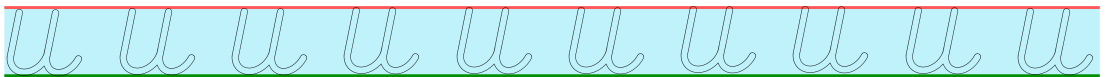
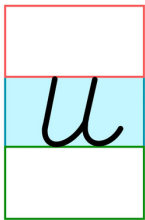
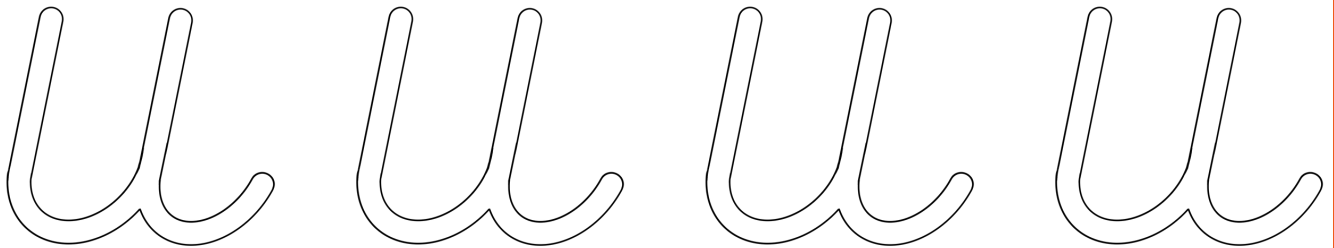
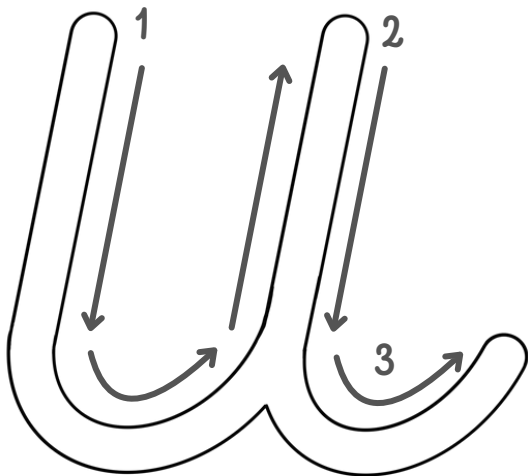

u

k

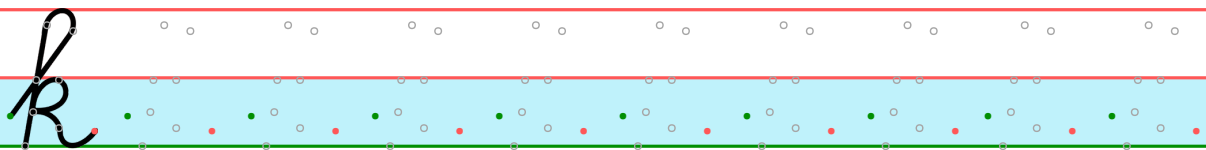
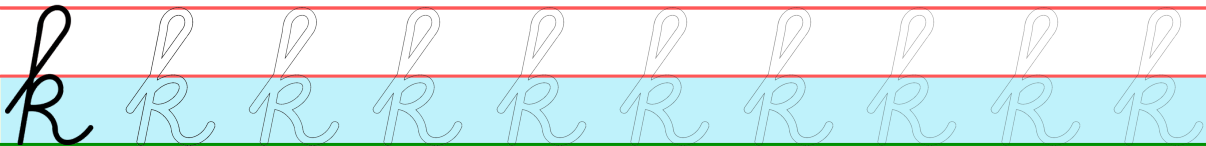
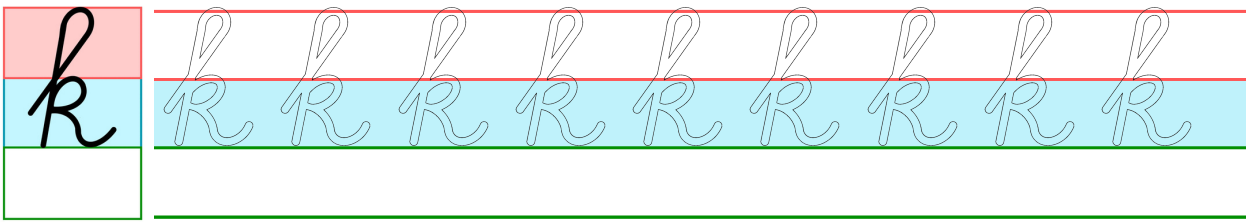
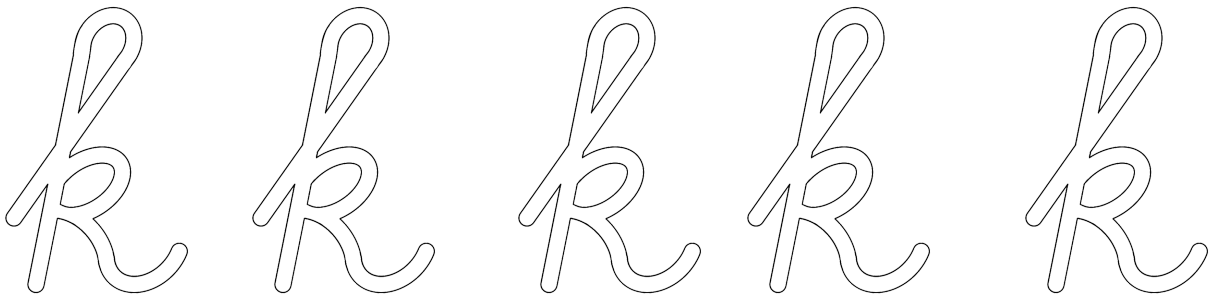
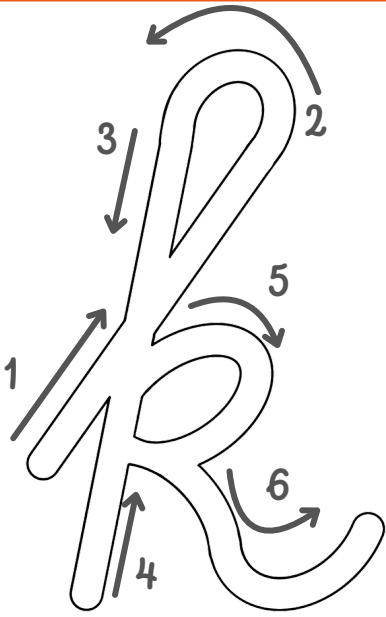

a

f

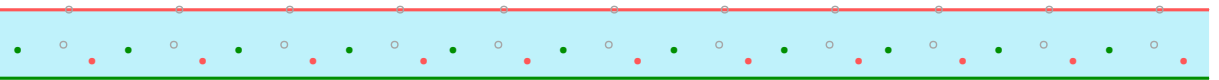
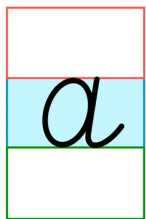
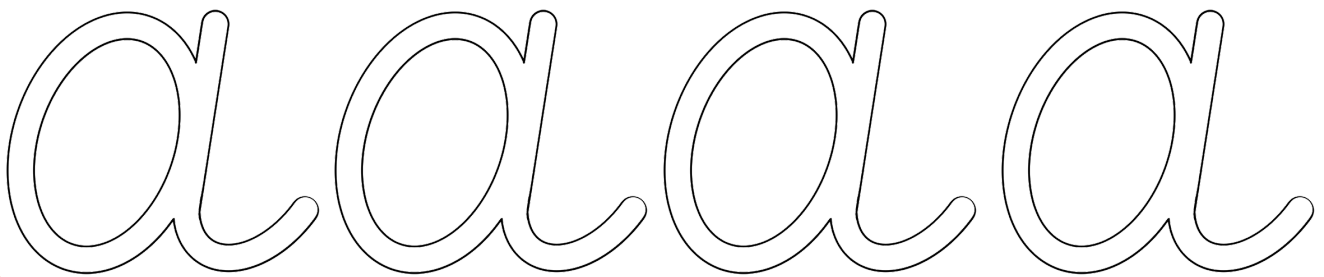
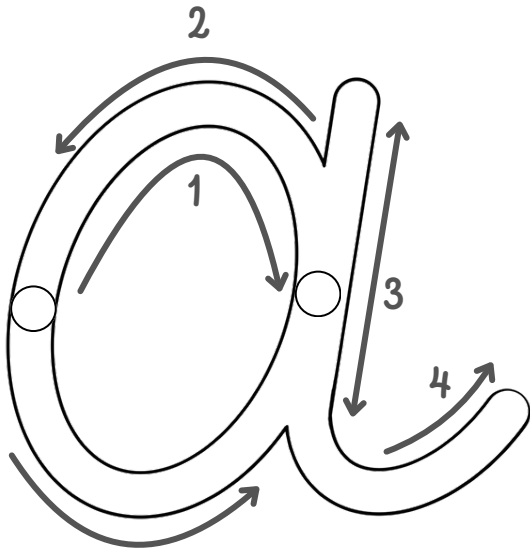

a	f
---	---

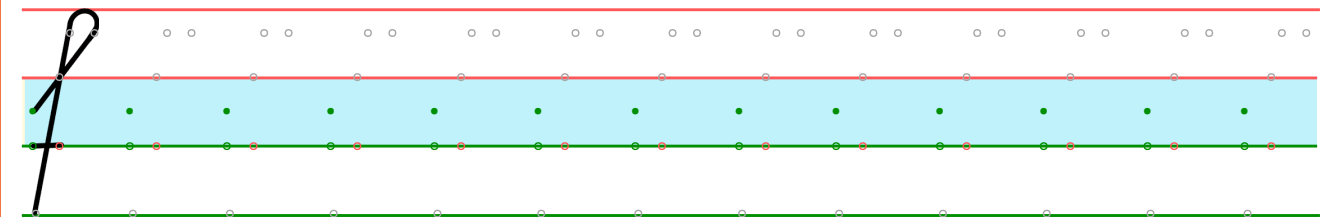
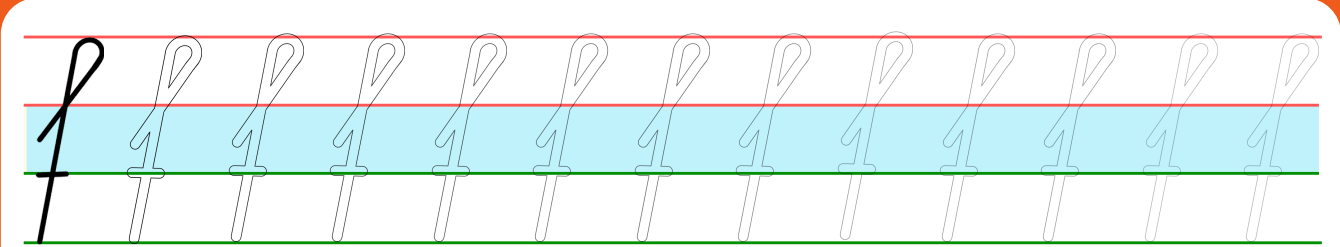
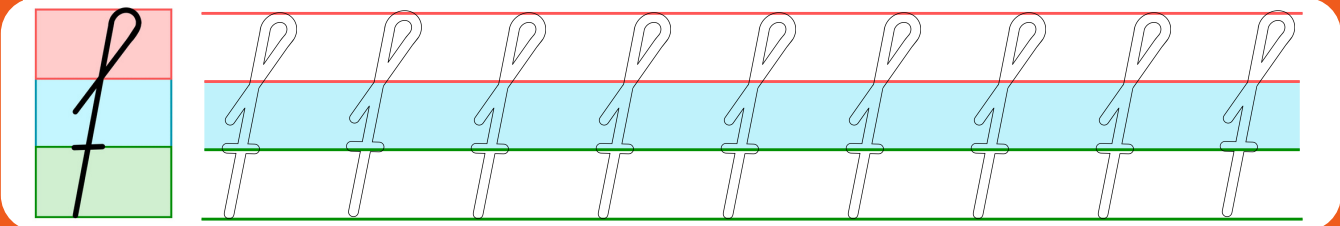
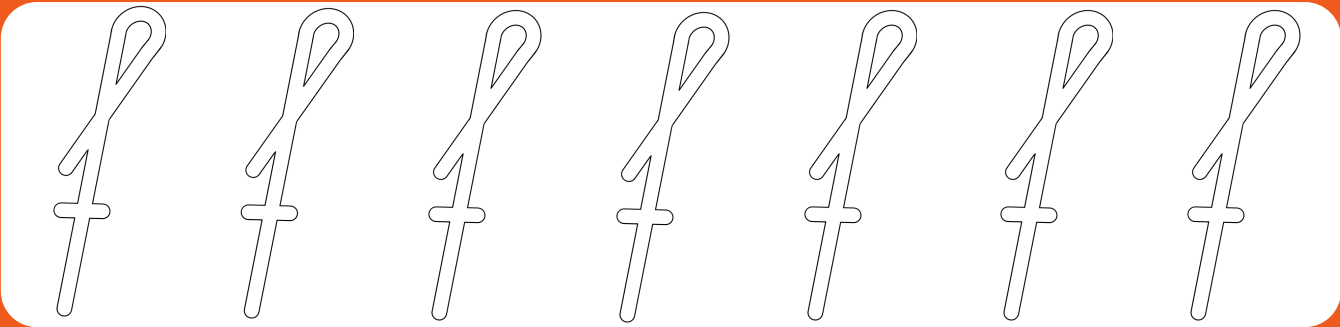
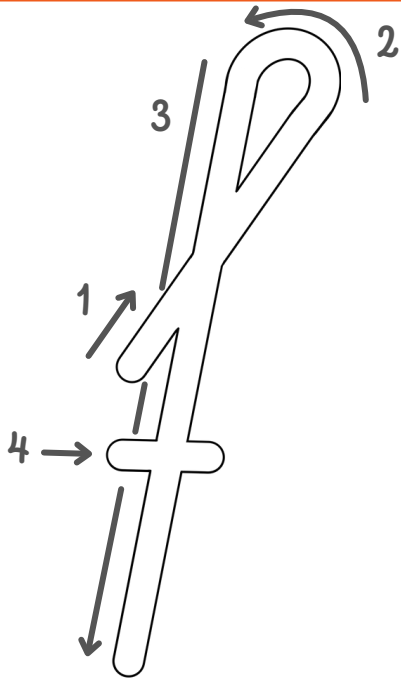

d	ui	f
---	----	---

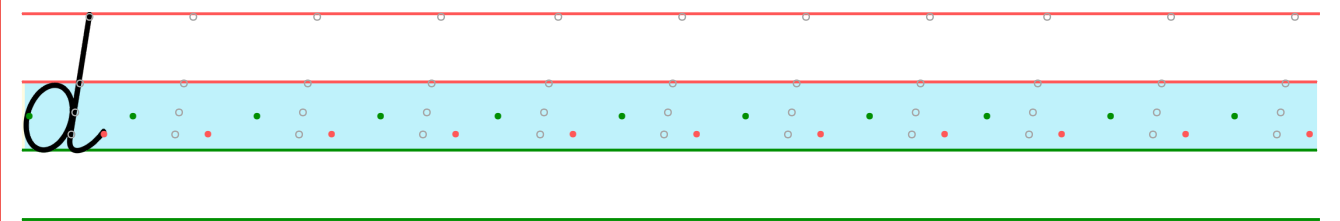
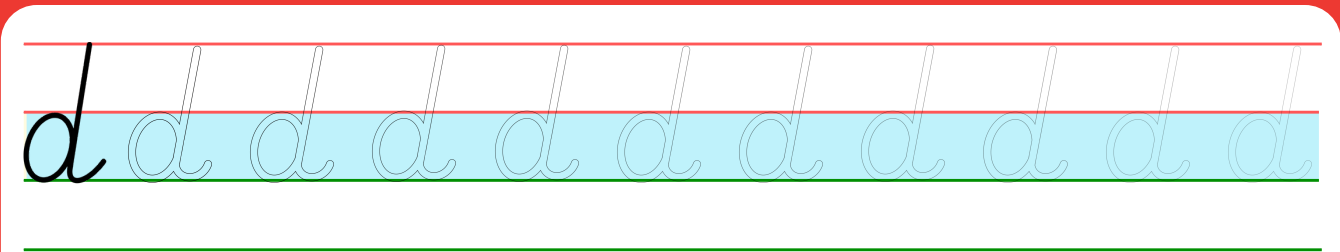
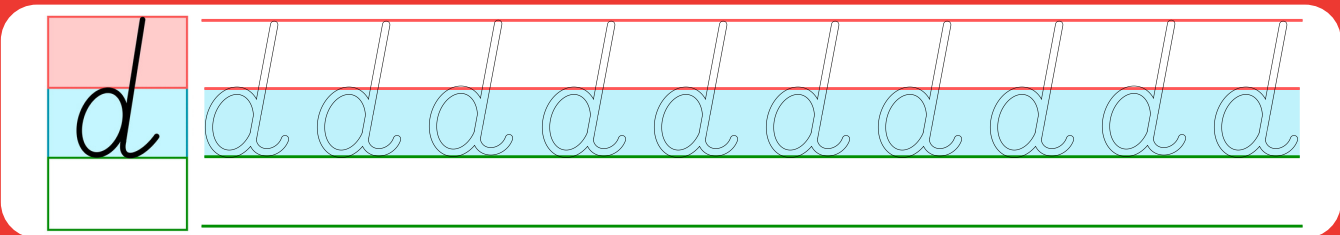
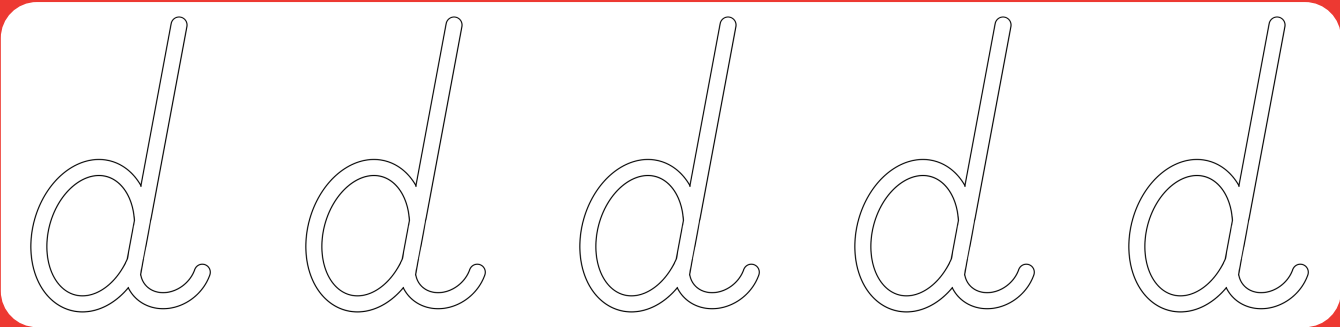
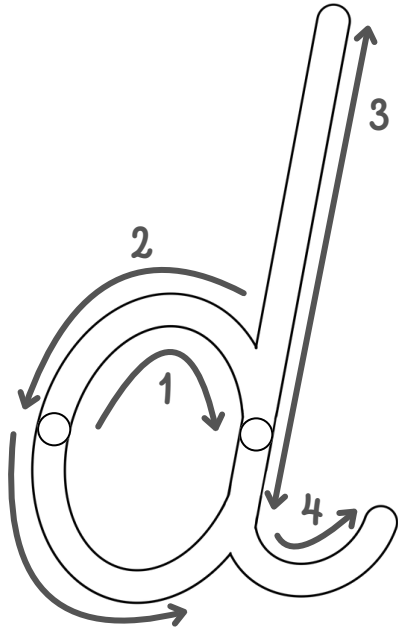

d ui f

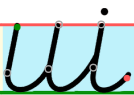
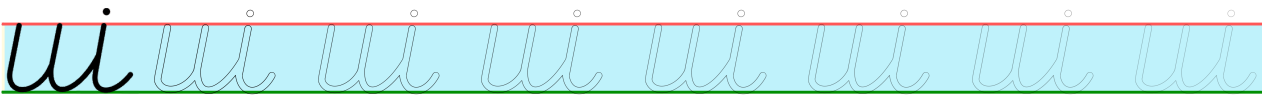
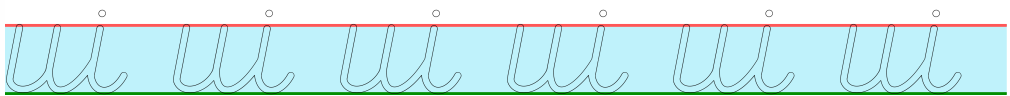
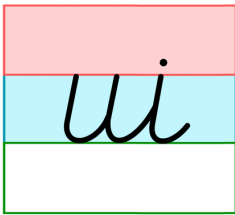
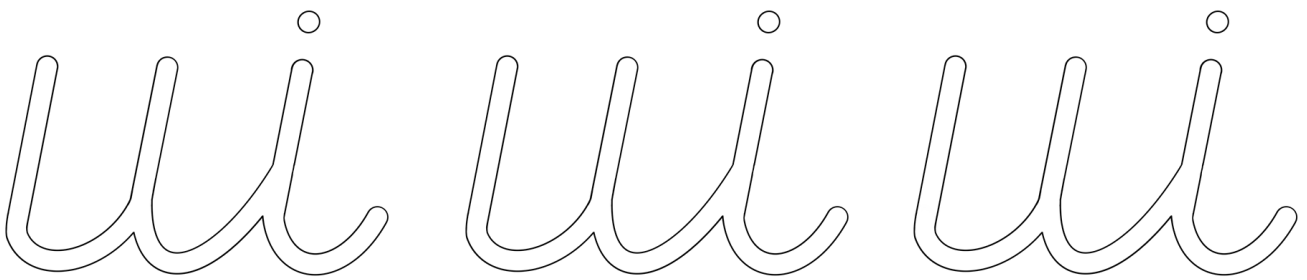
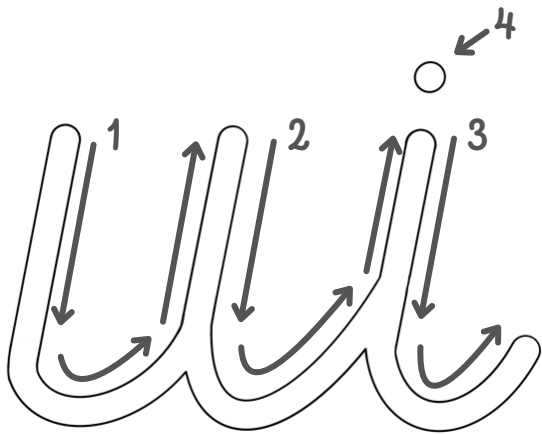

d ui f

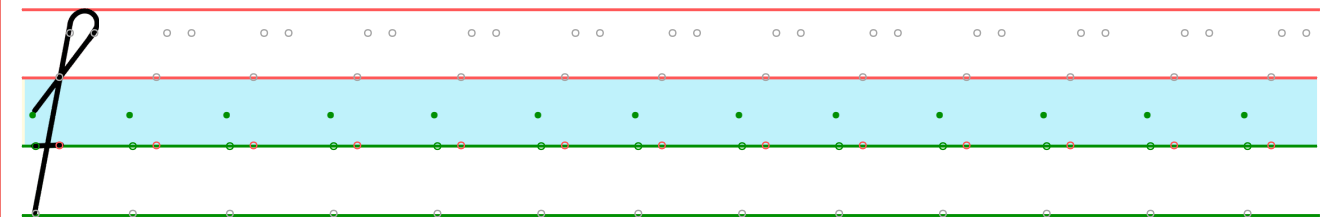
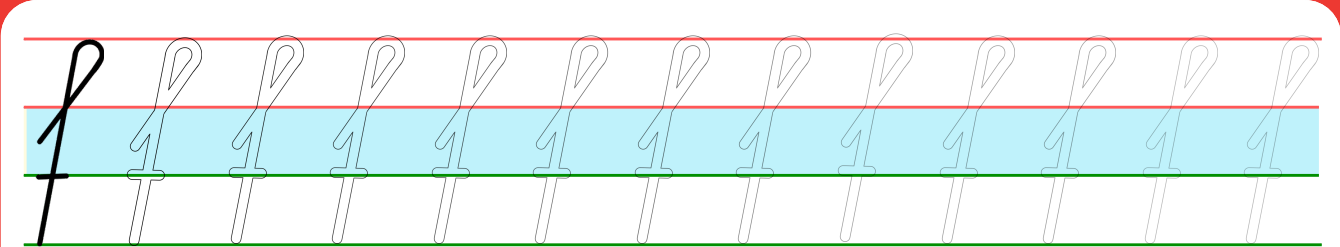
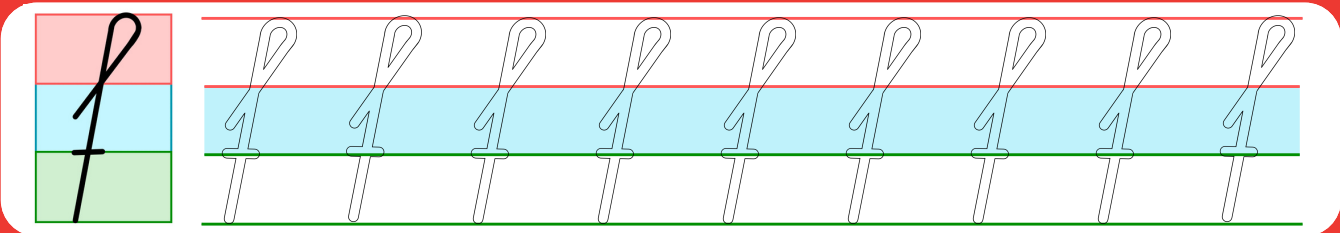
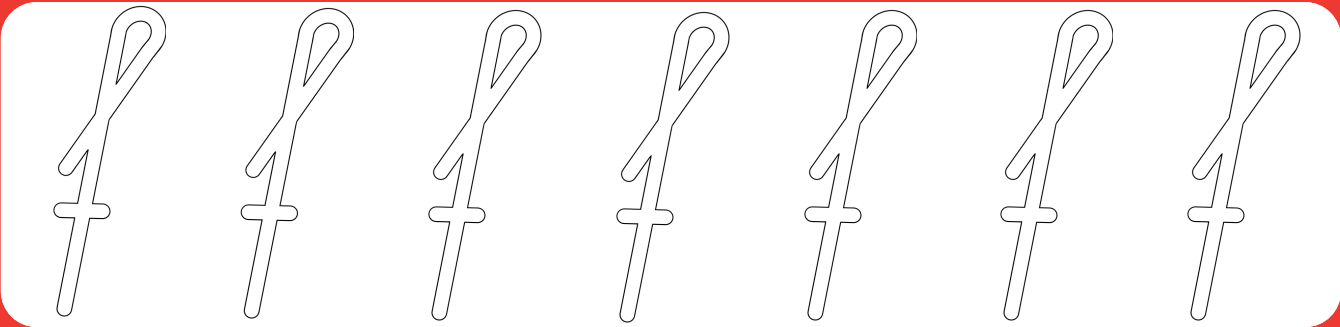
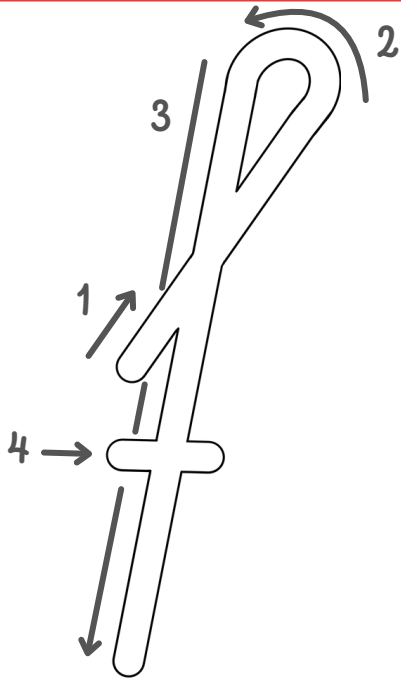

v i s

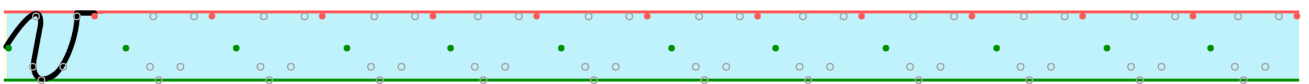
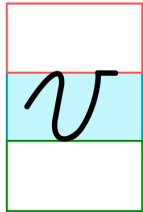
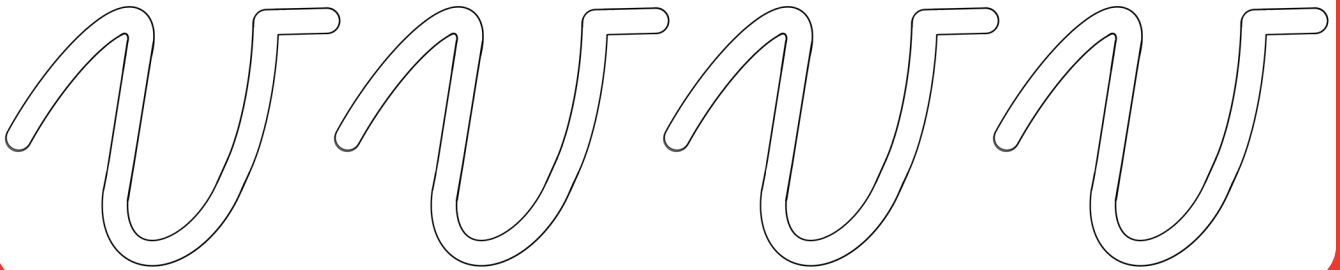
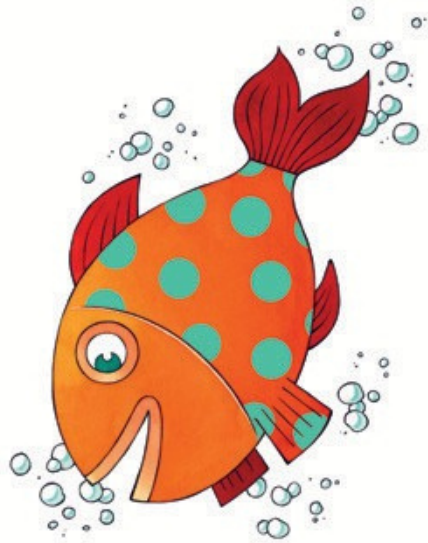
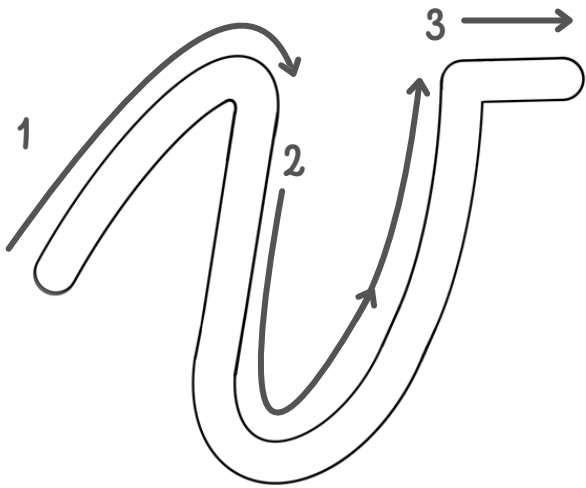

v i s

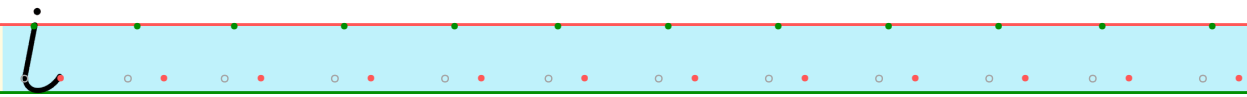
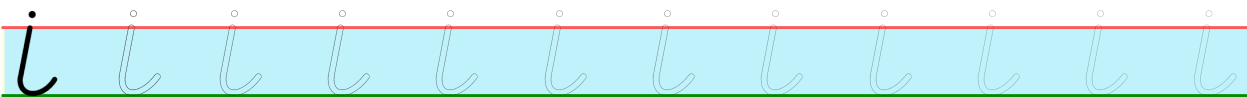
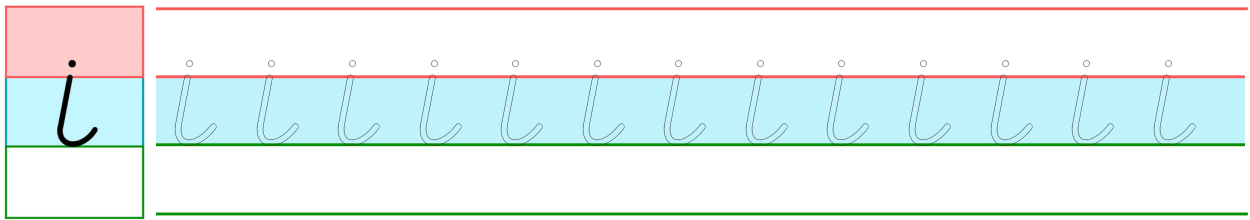
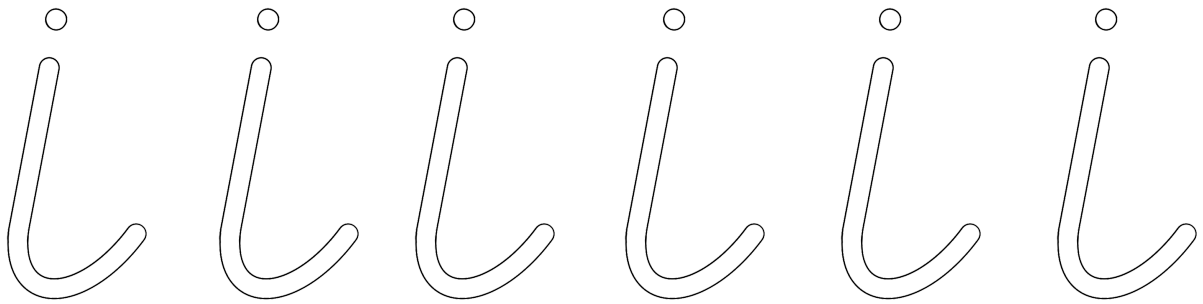
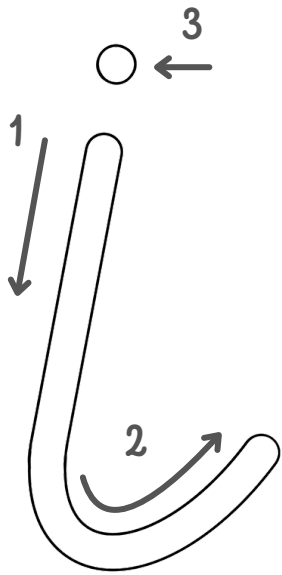

v i s

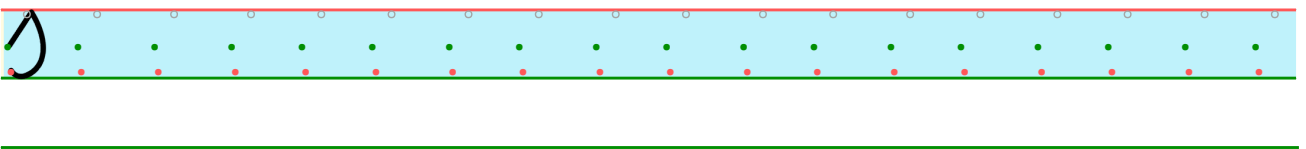
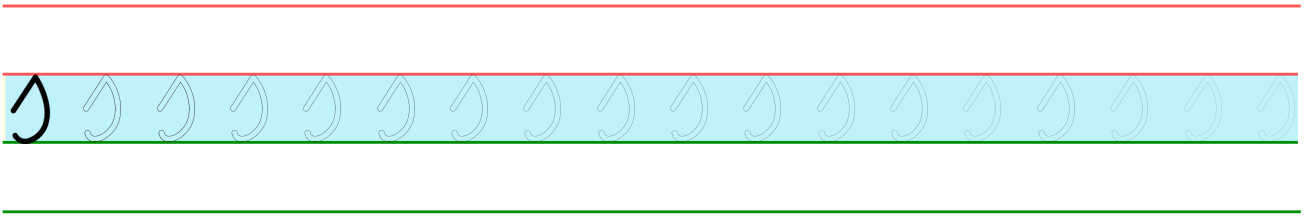
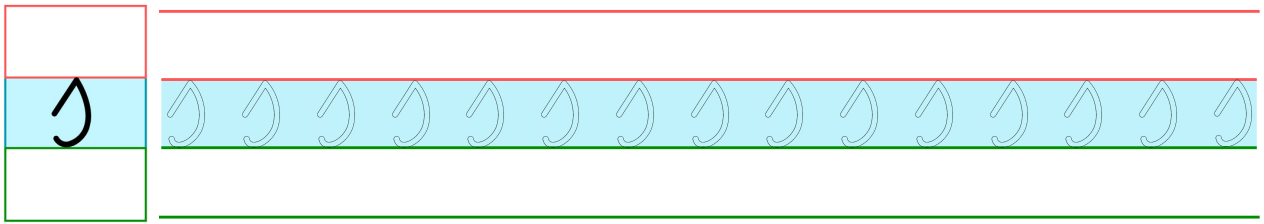
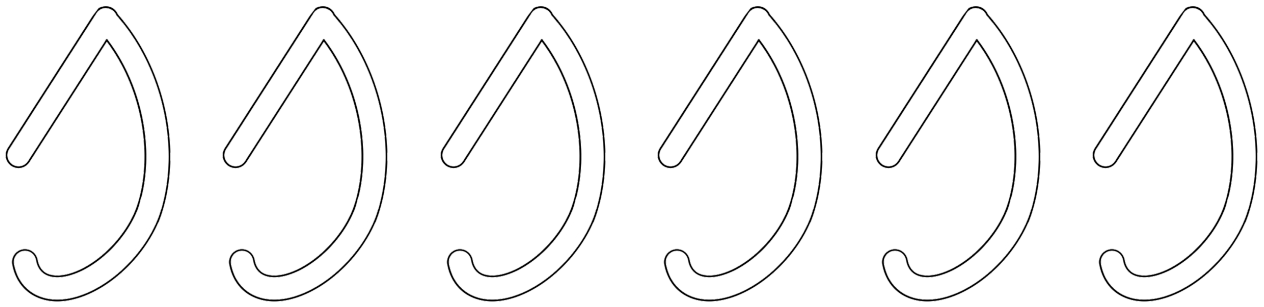
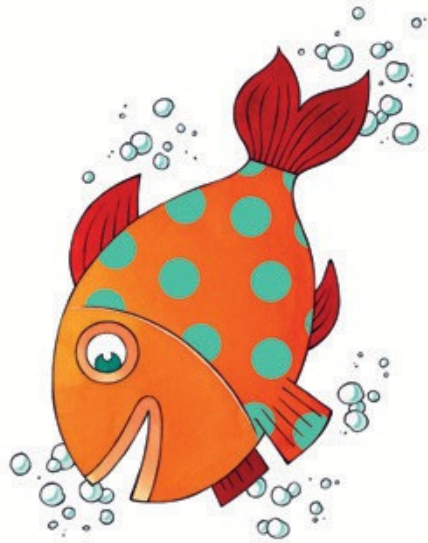
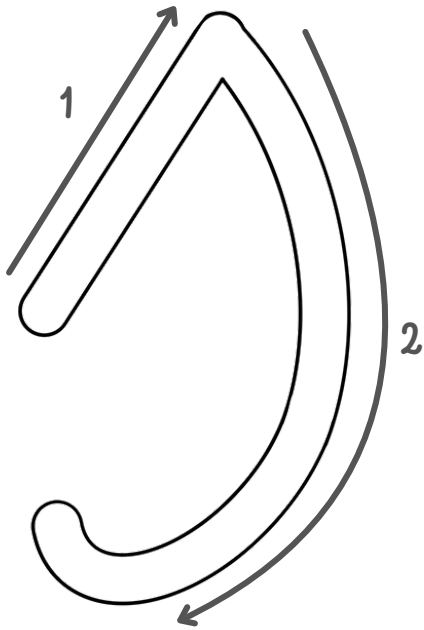

z a k

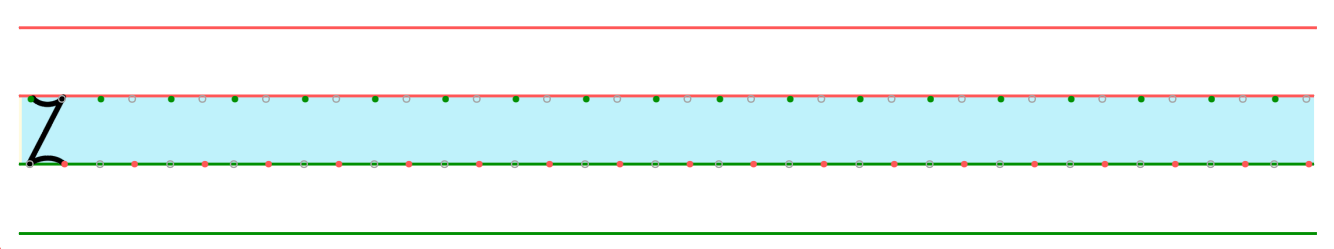
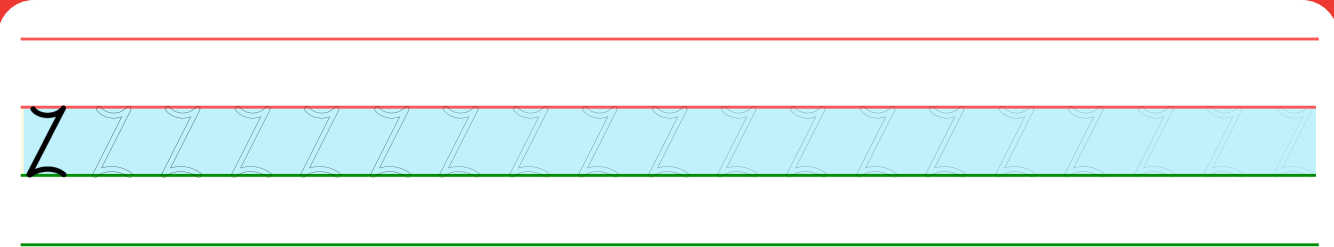
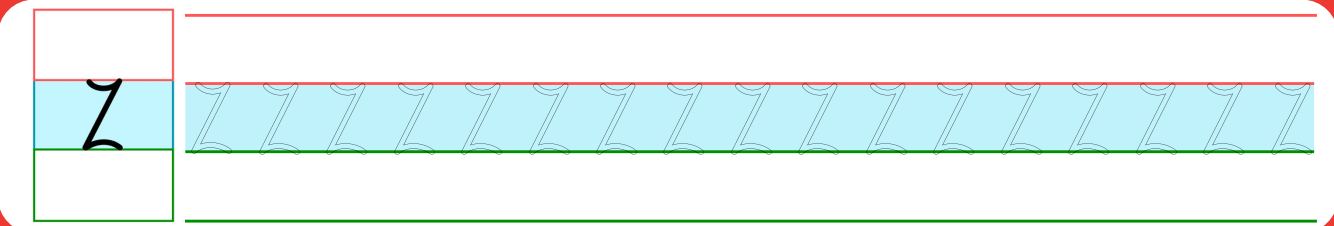
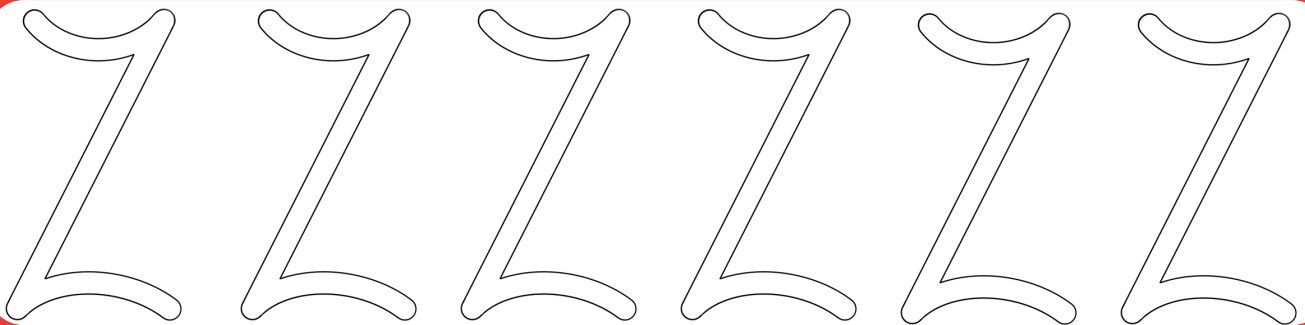
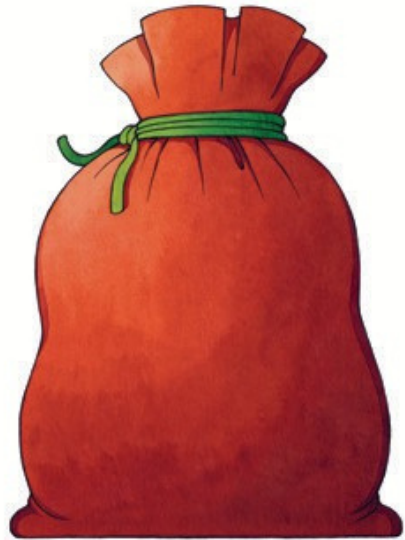
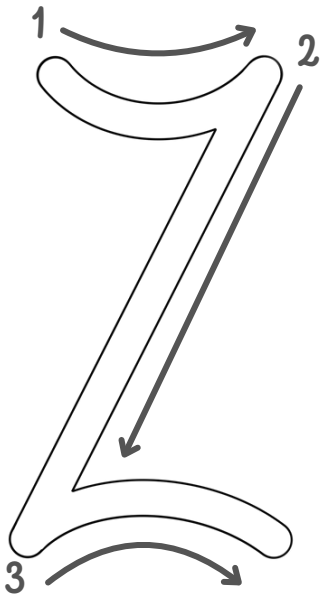

z a k

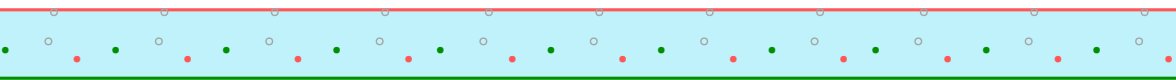
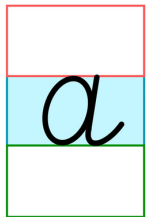
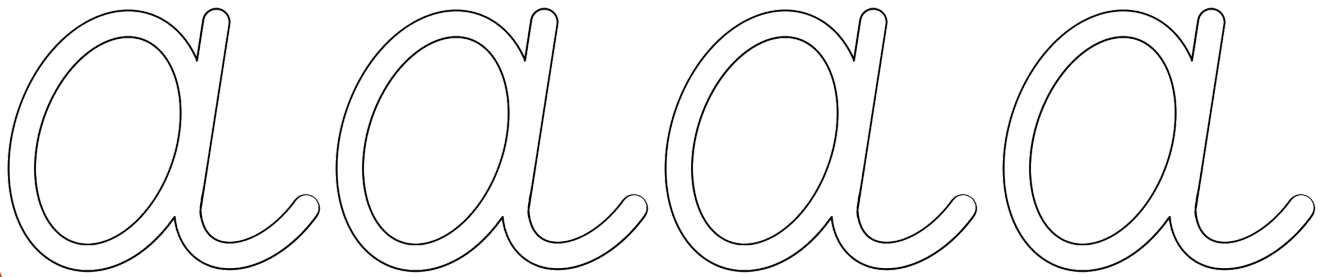
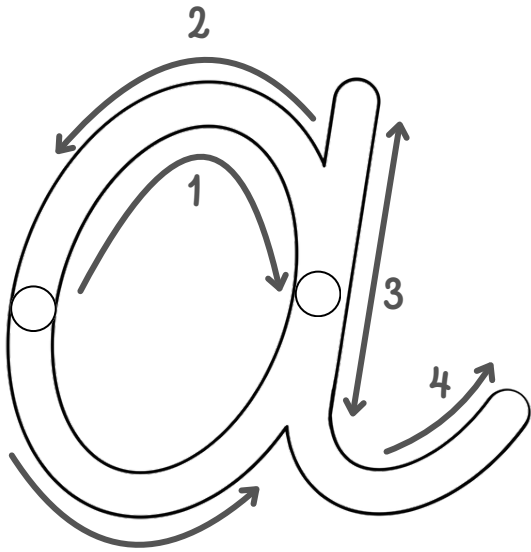

z a k

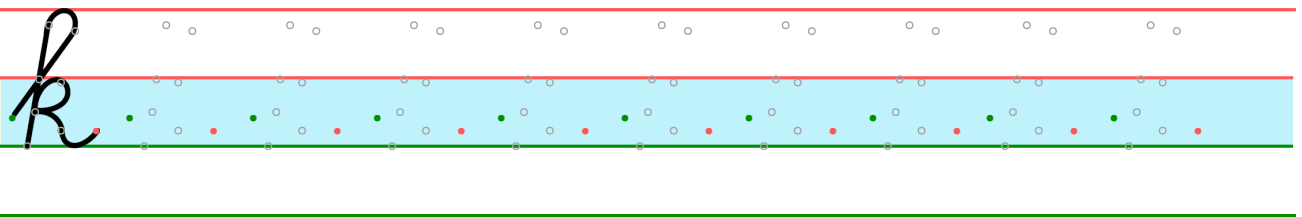
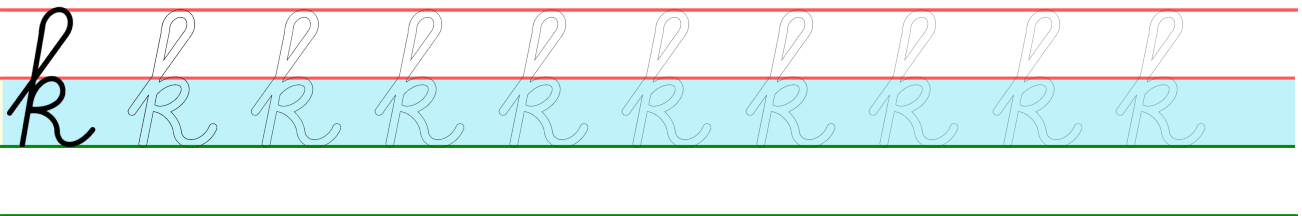
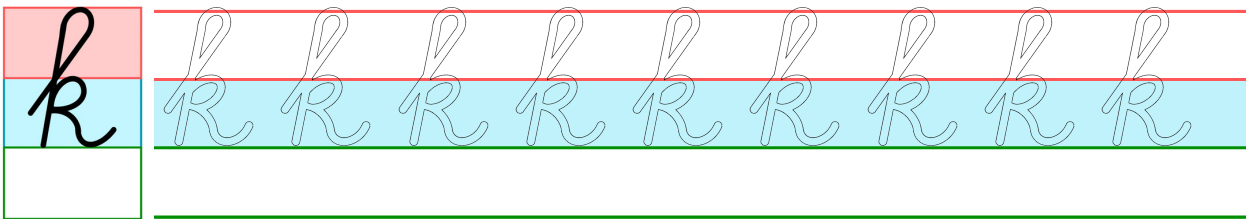
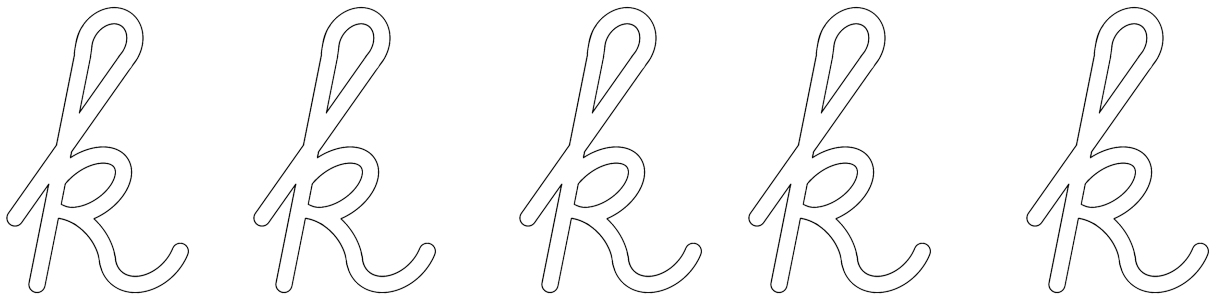
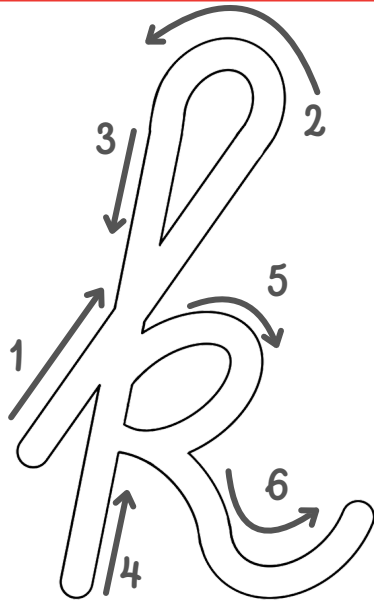

h u i s

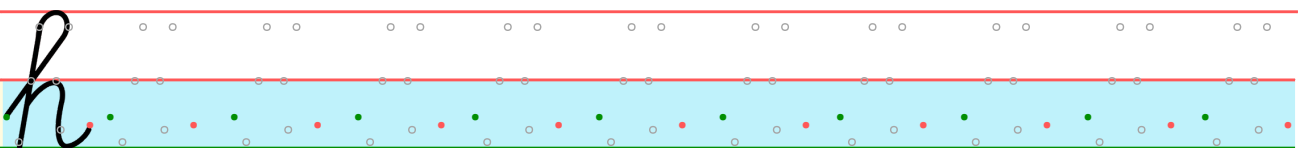
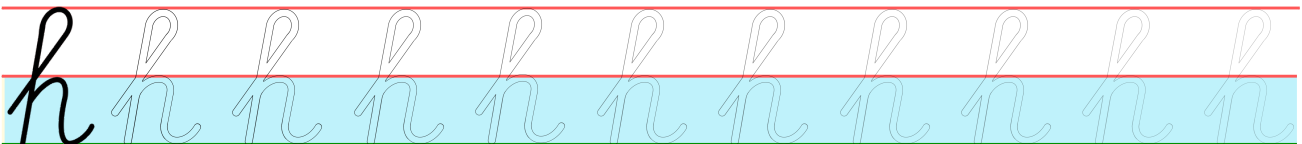
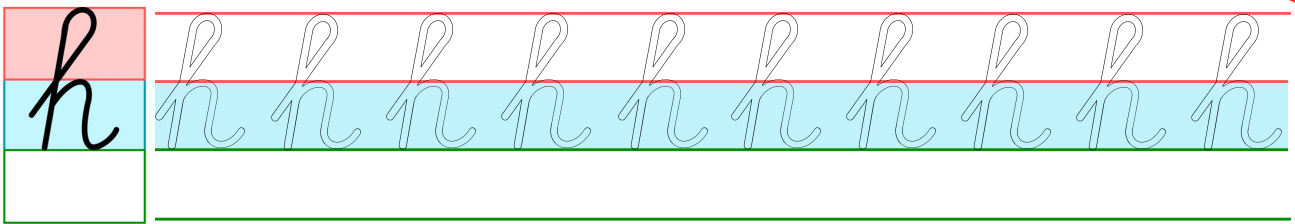
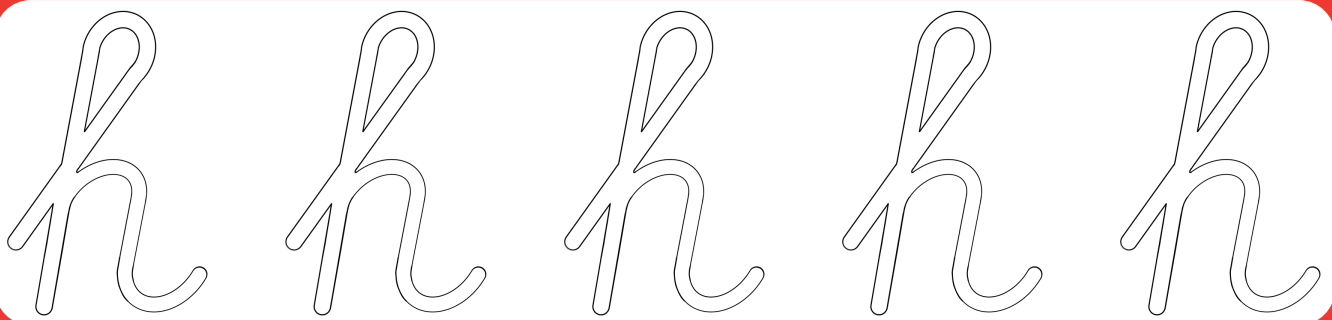
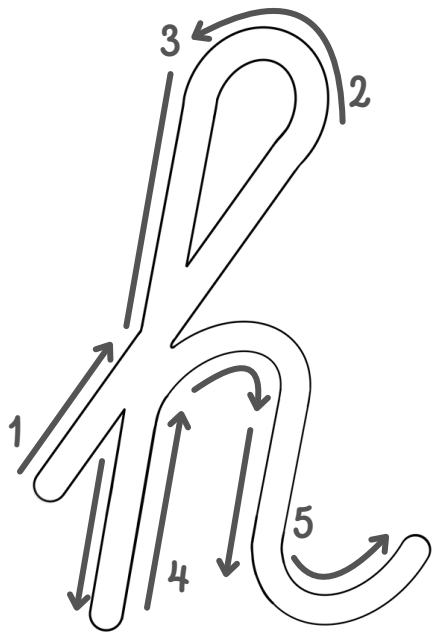

h u i s

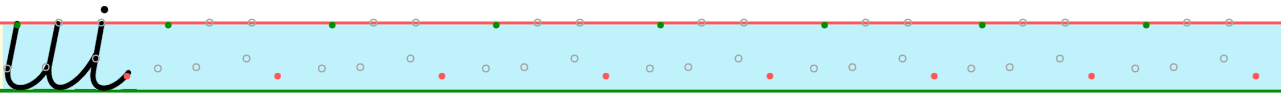
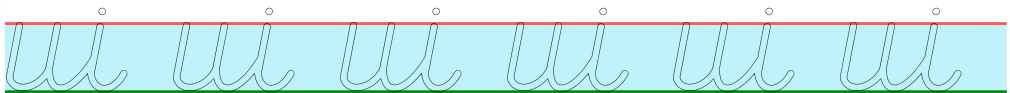
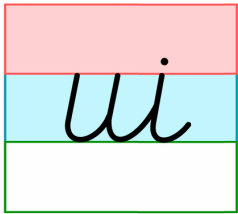
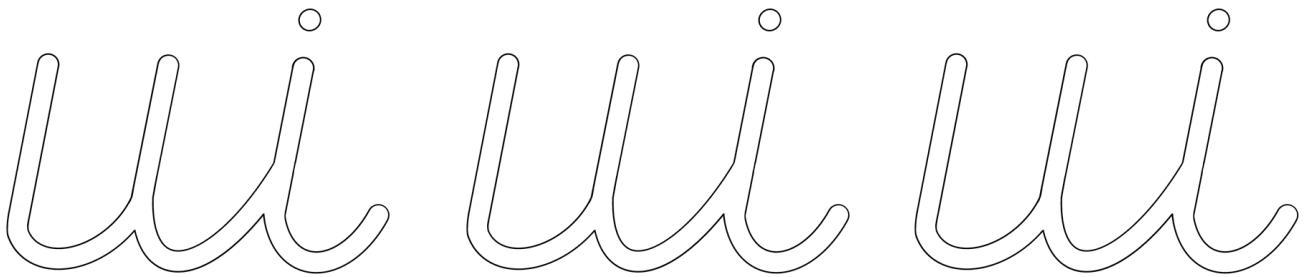
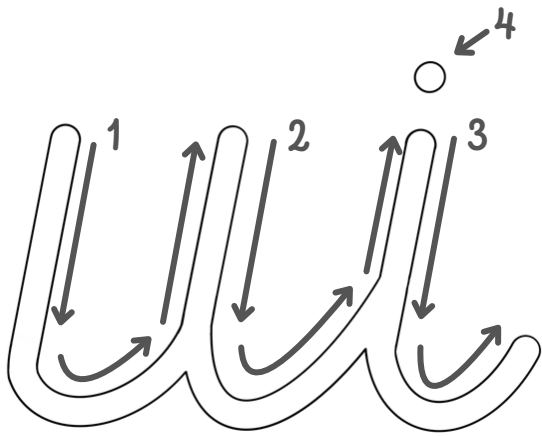

h u i s

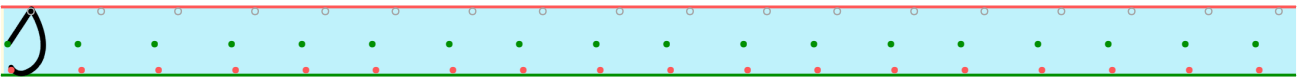
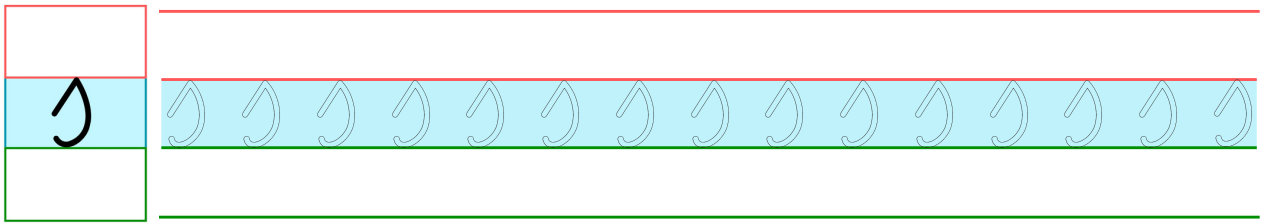
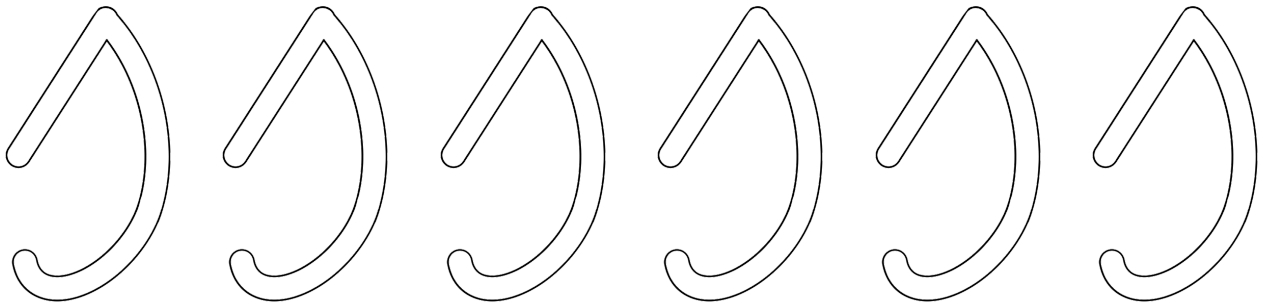
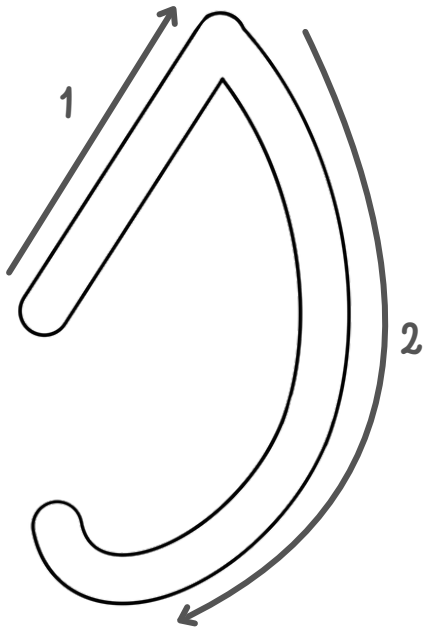

b oe k

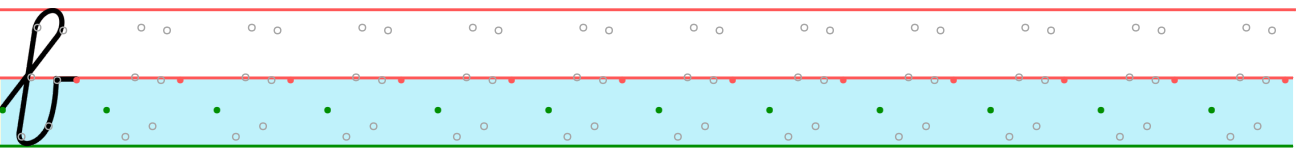
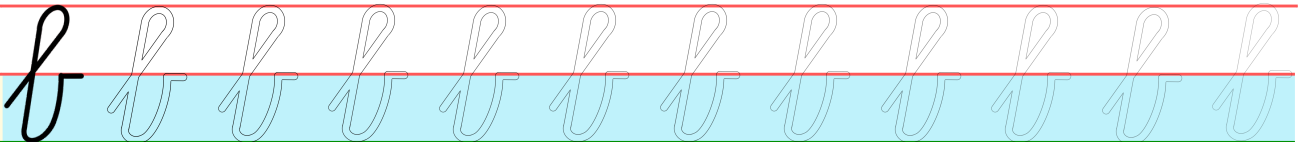
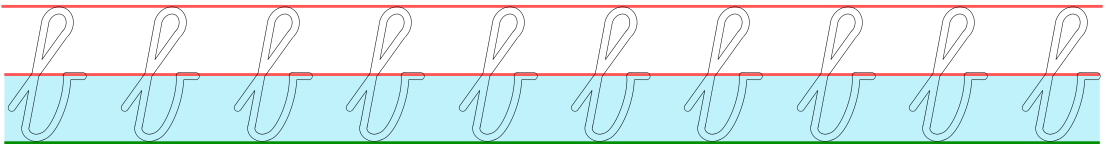
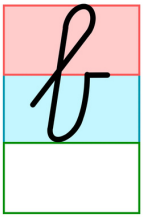
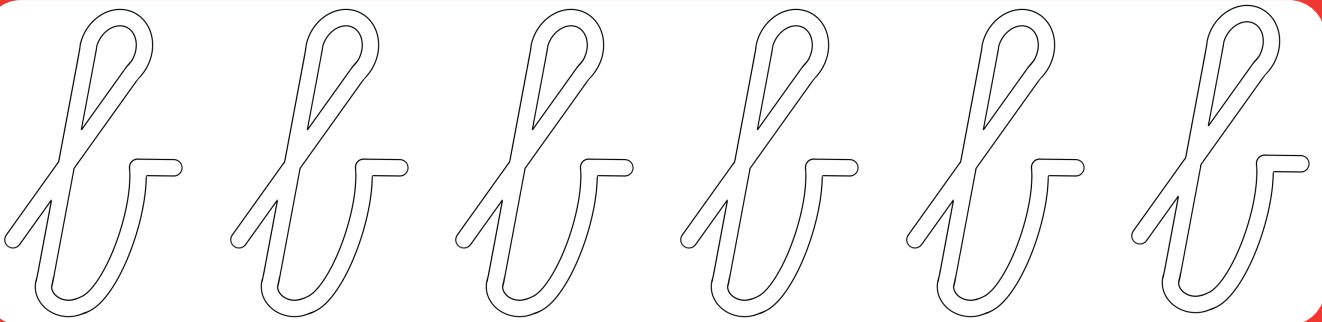
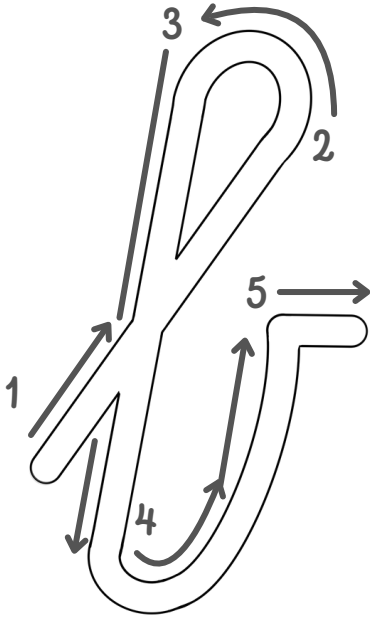

b oe k

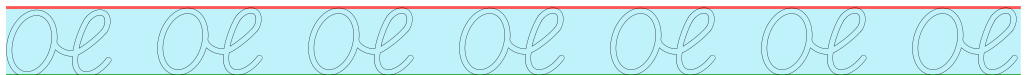
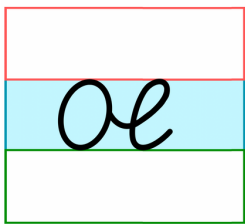
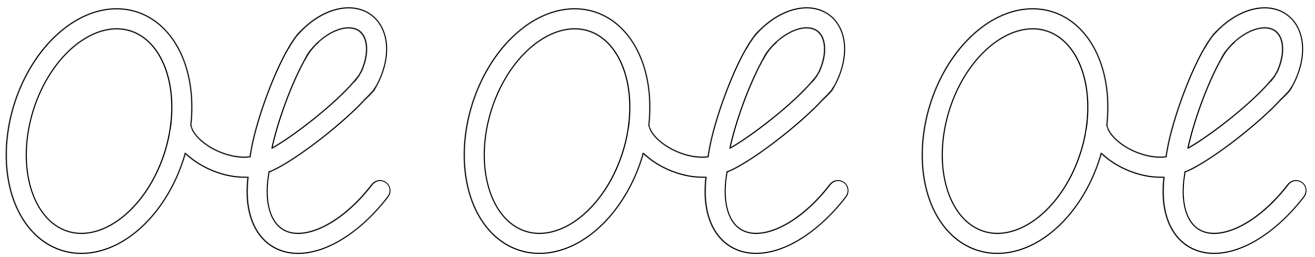
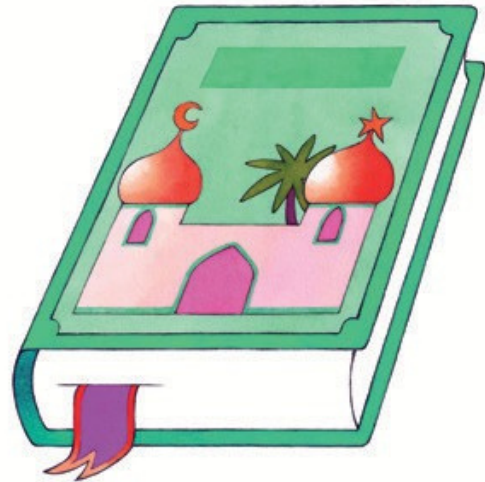
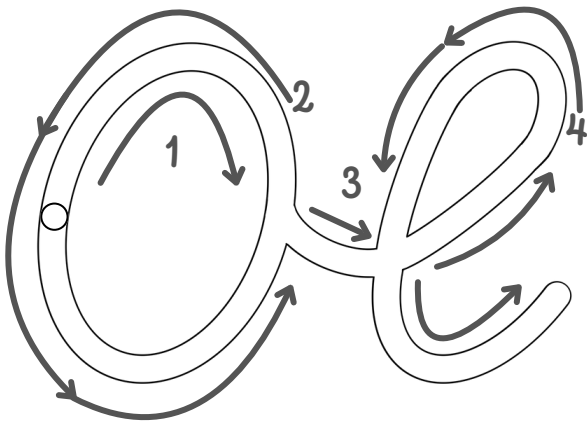

b oe k

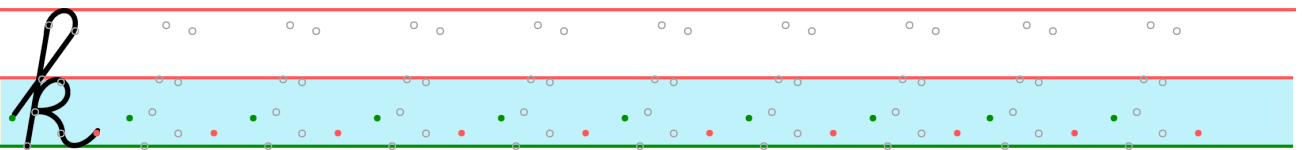
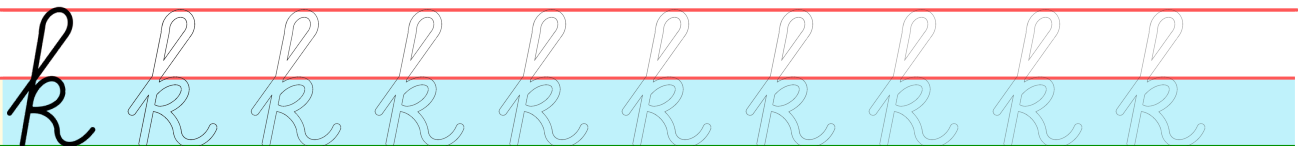
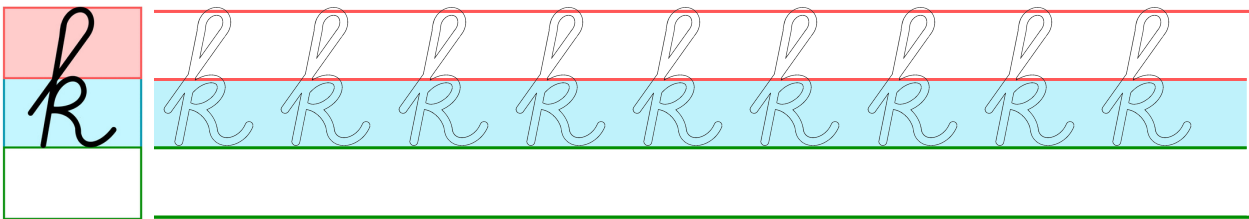
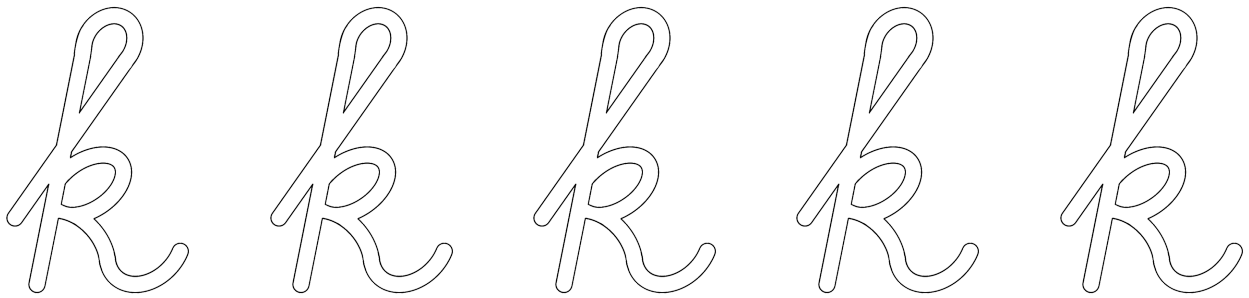
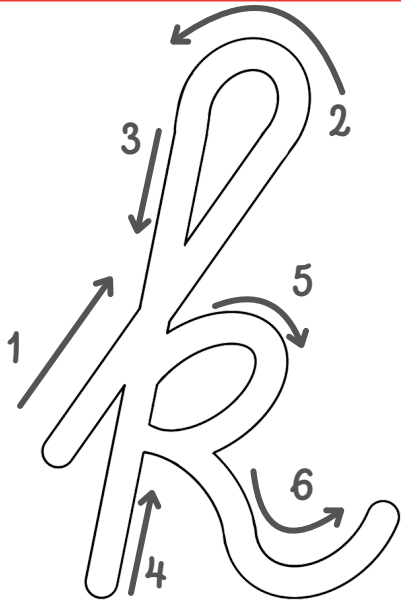

j a s

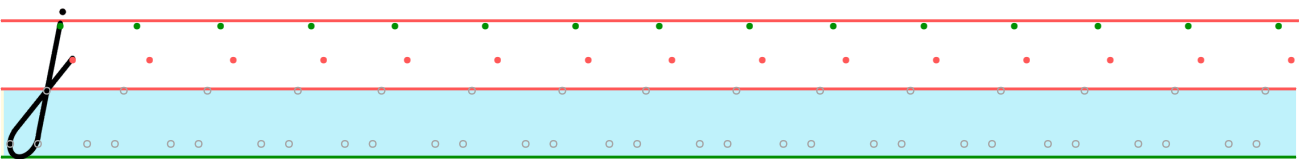
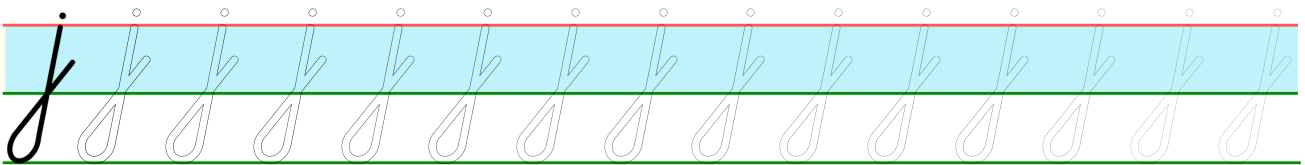
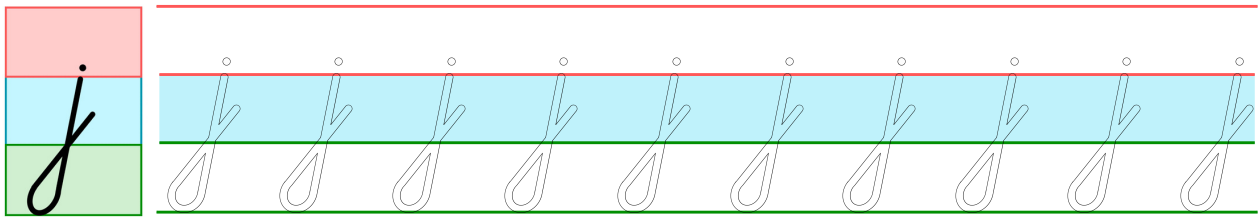
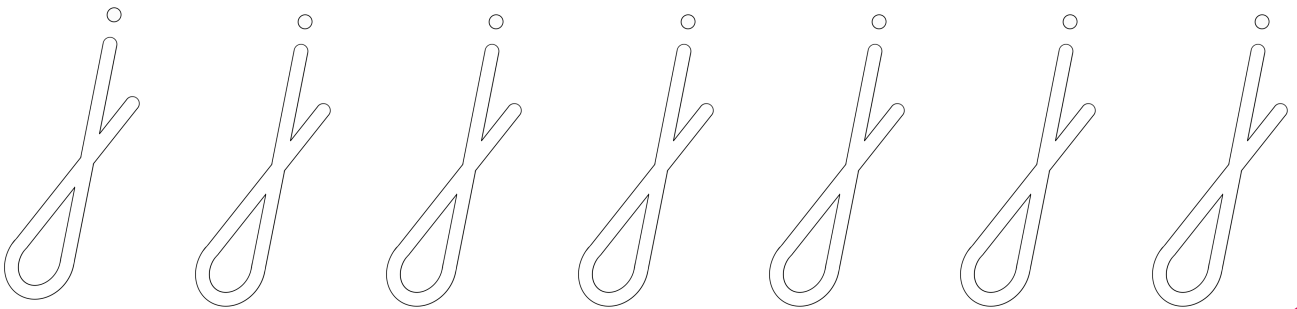
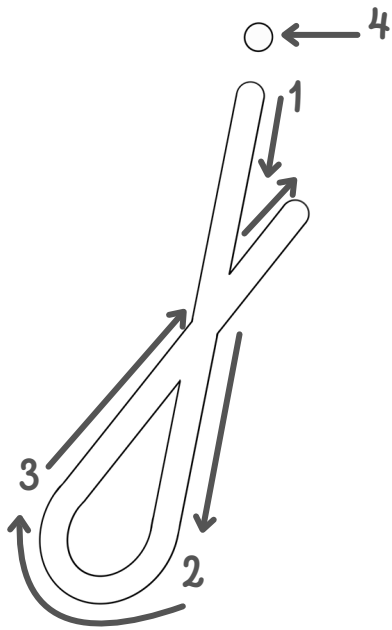

j a s

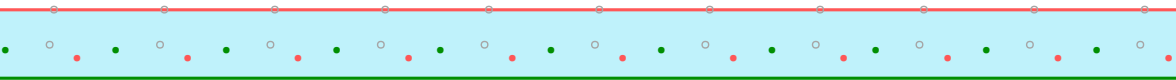
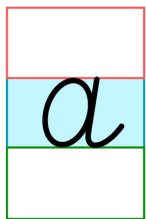
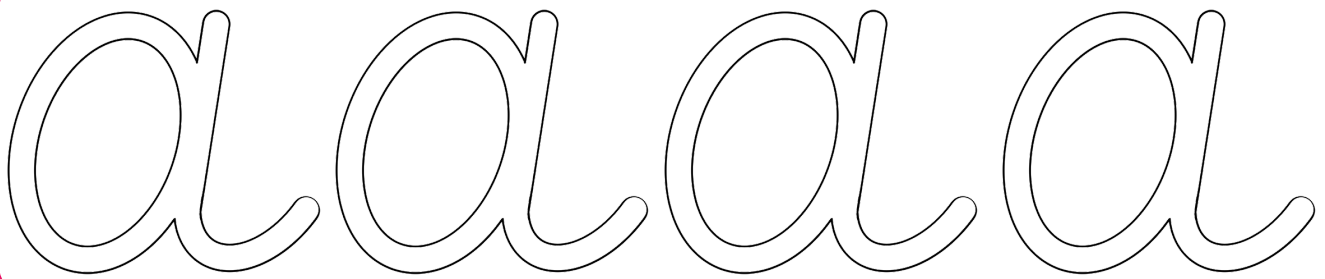
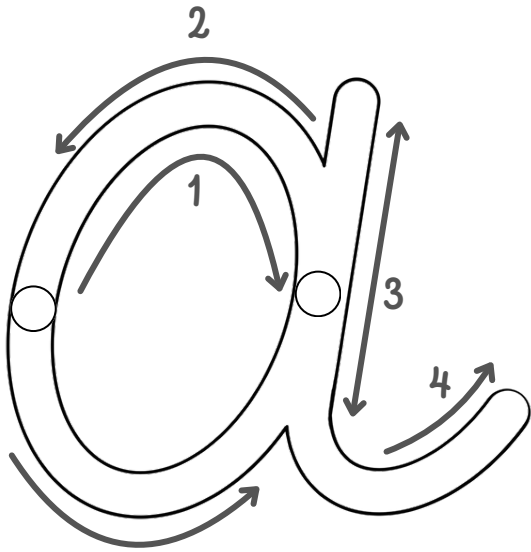

j a s

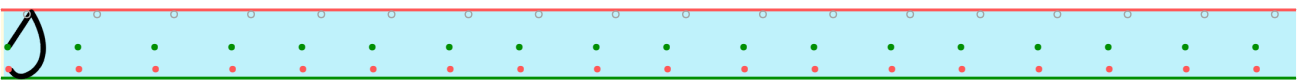
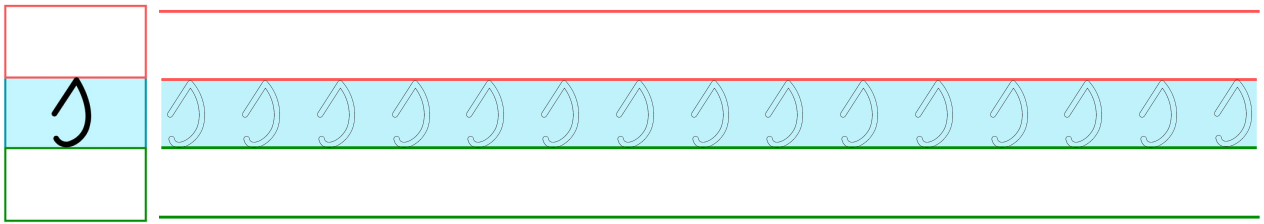
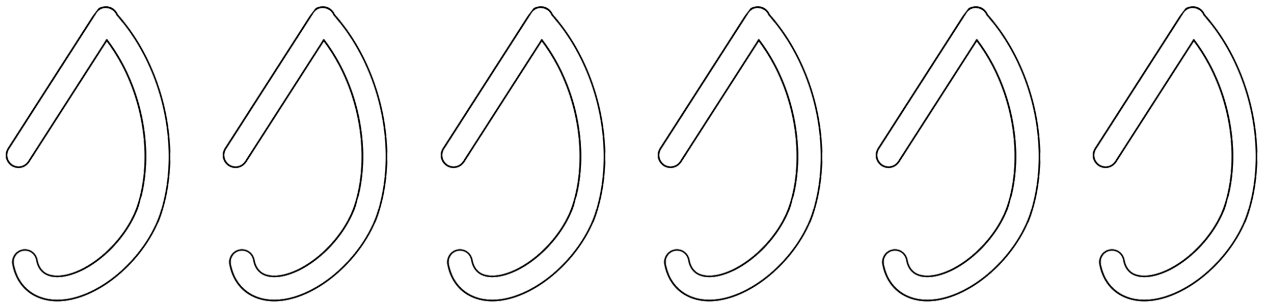
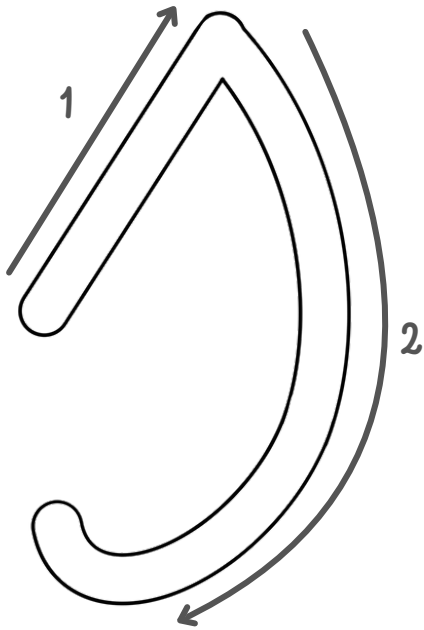

w ie l

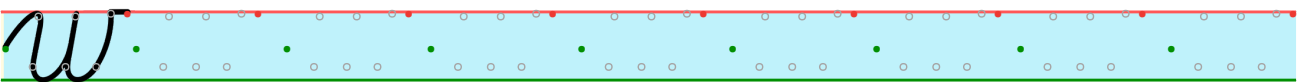
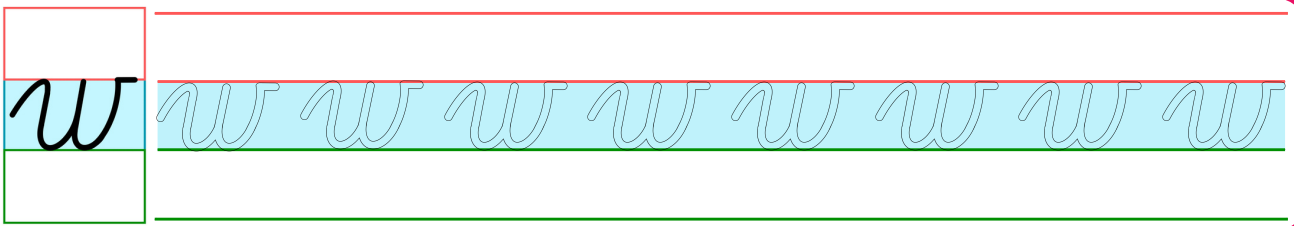
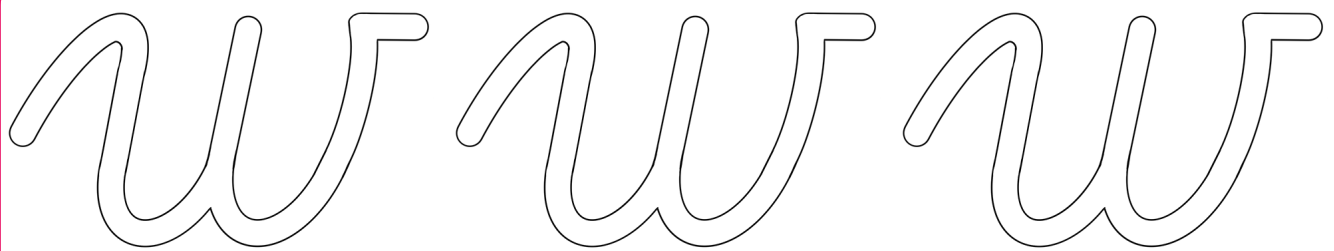
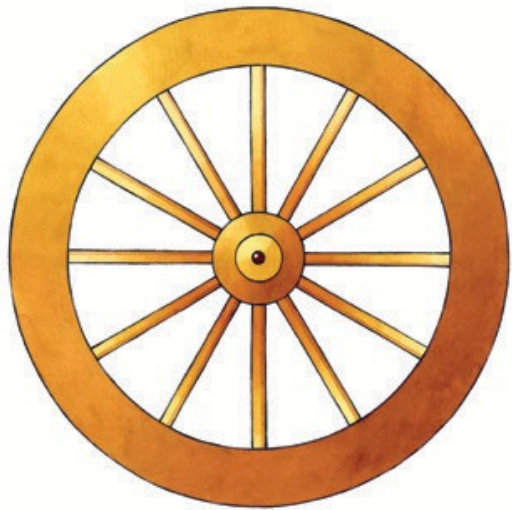
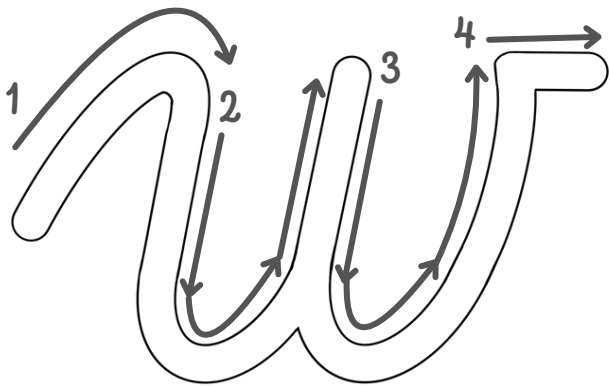

w | ie | l

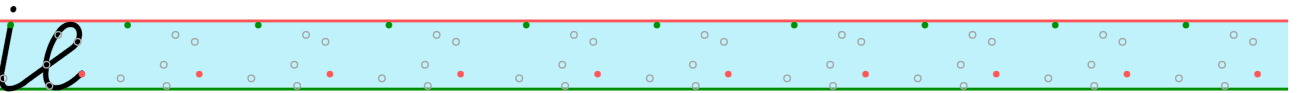
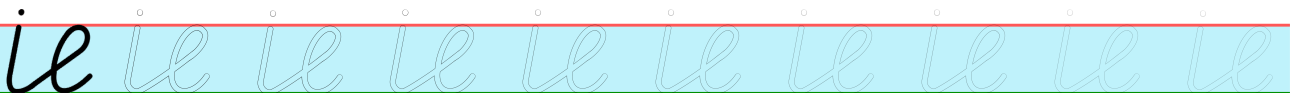
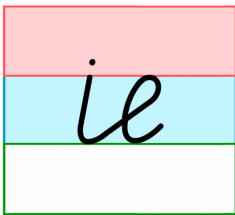
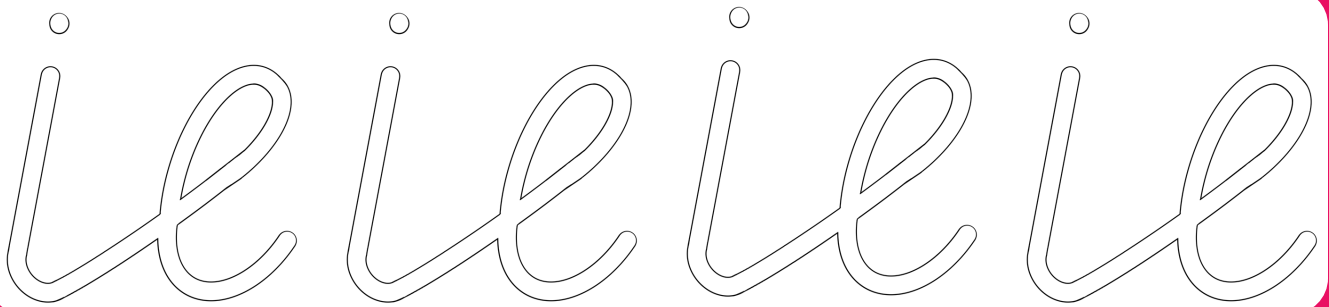
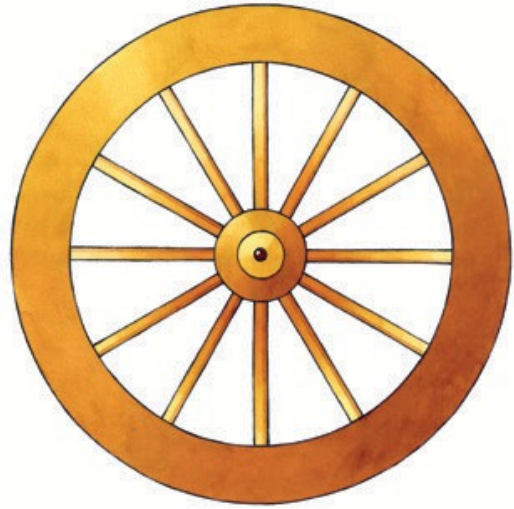
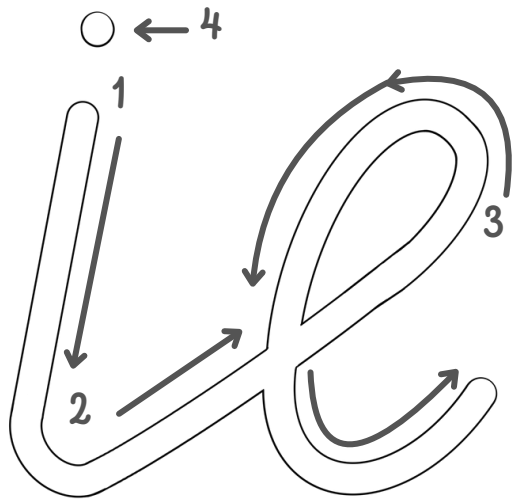

w | ie | l

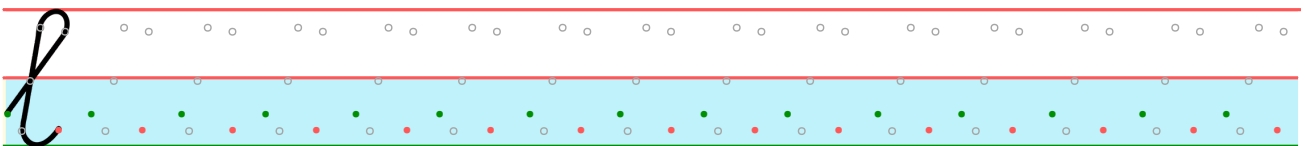
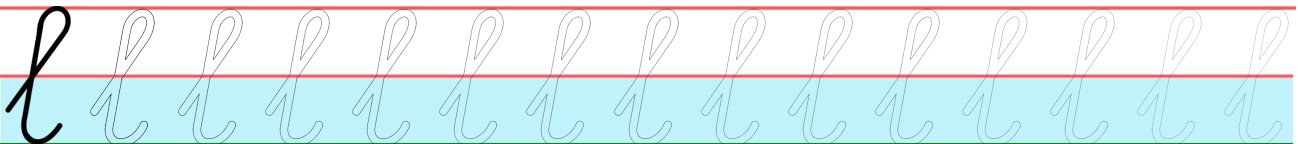
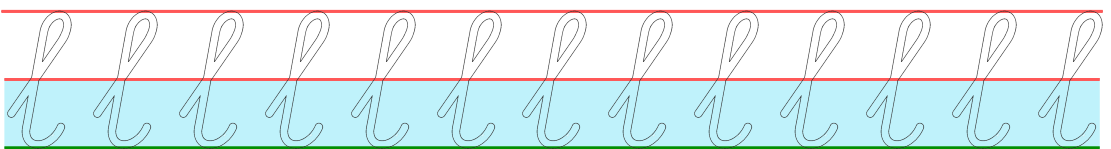
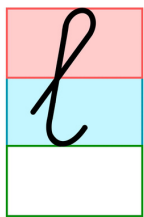
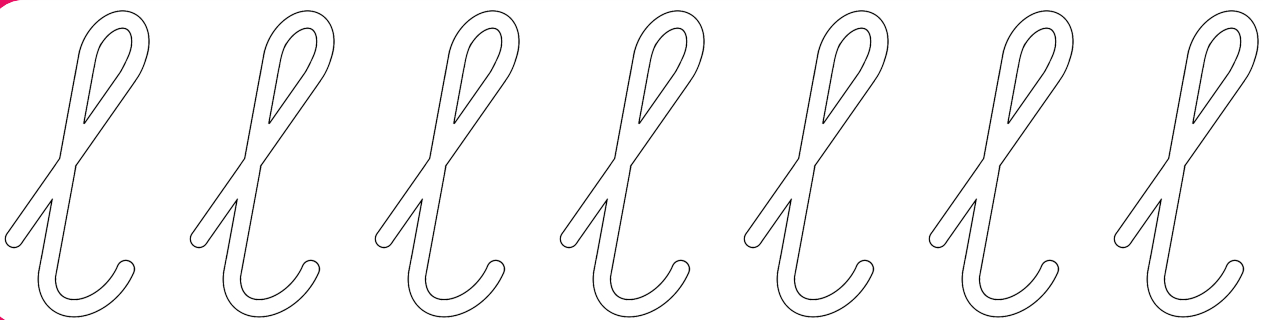
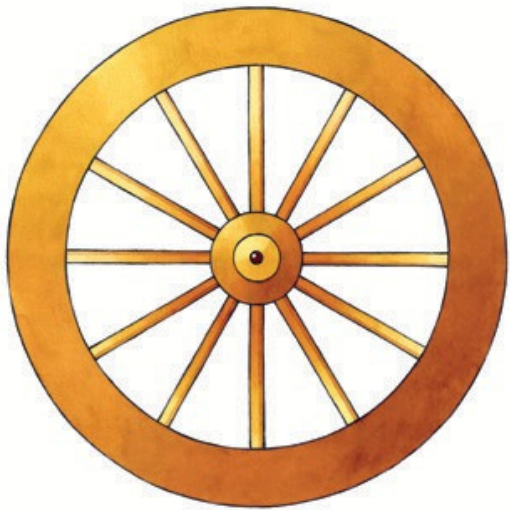
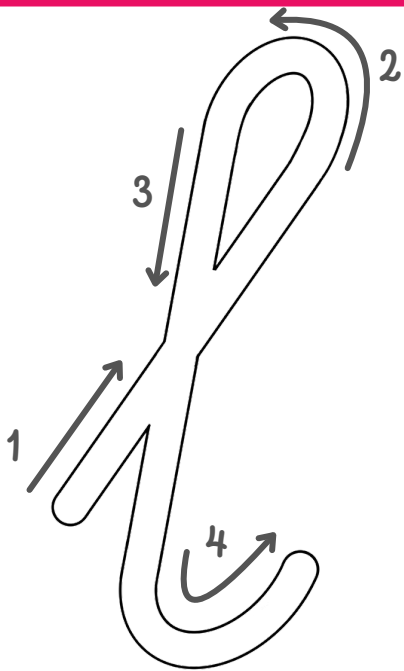

r eu s

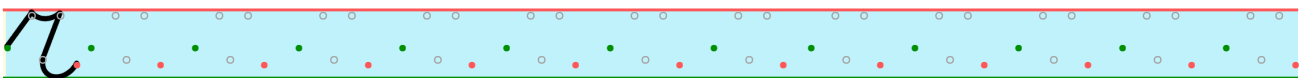
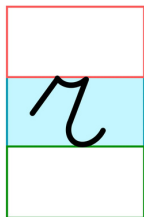
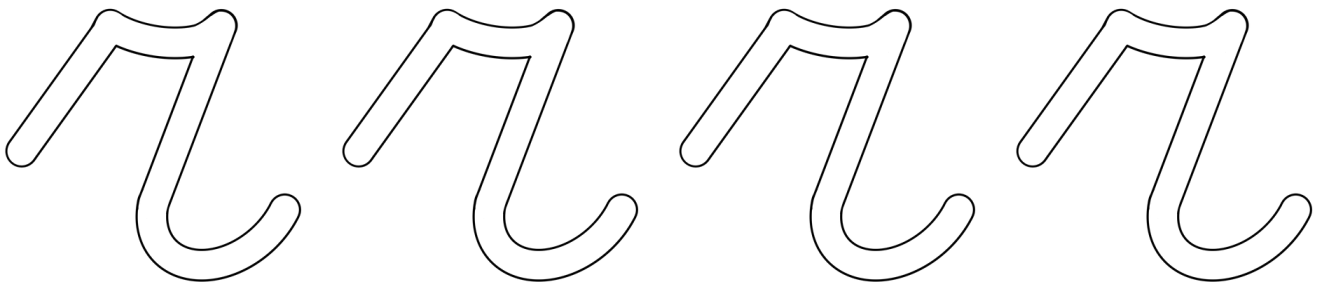
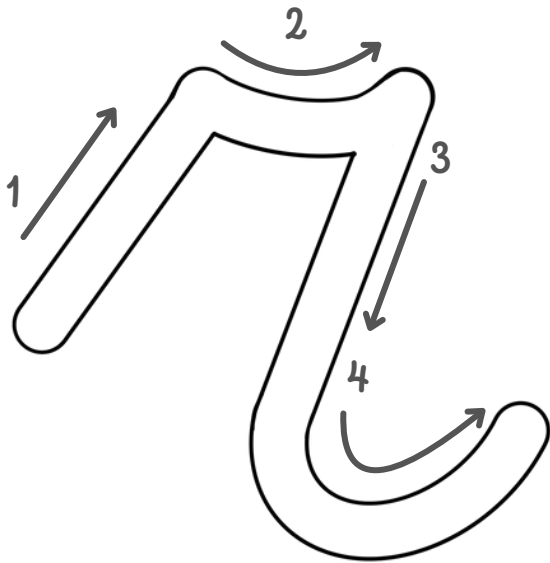

r eu s

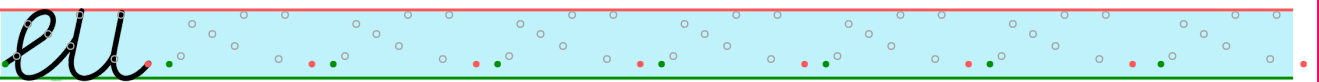
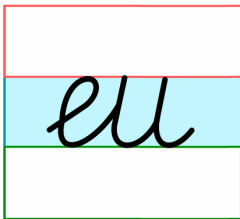
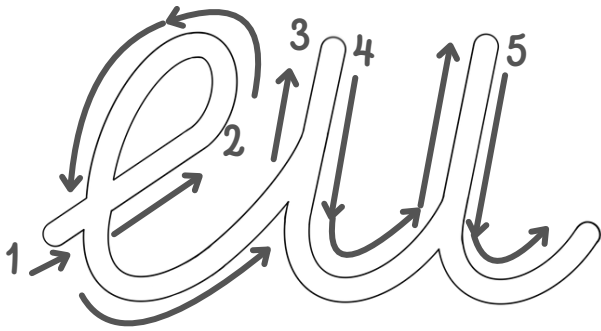

r eu s

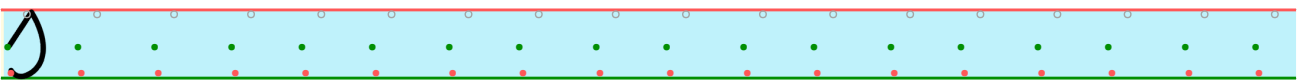
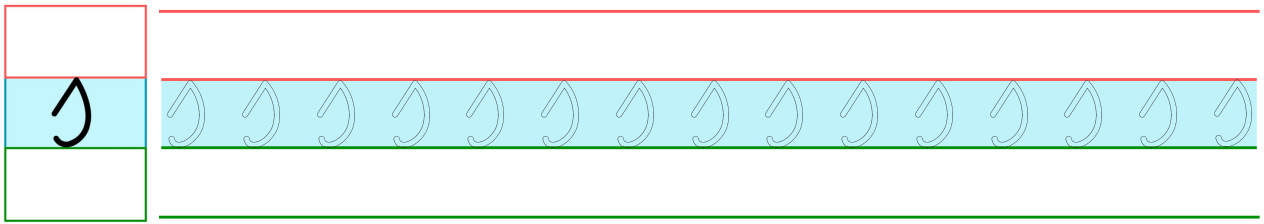
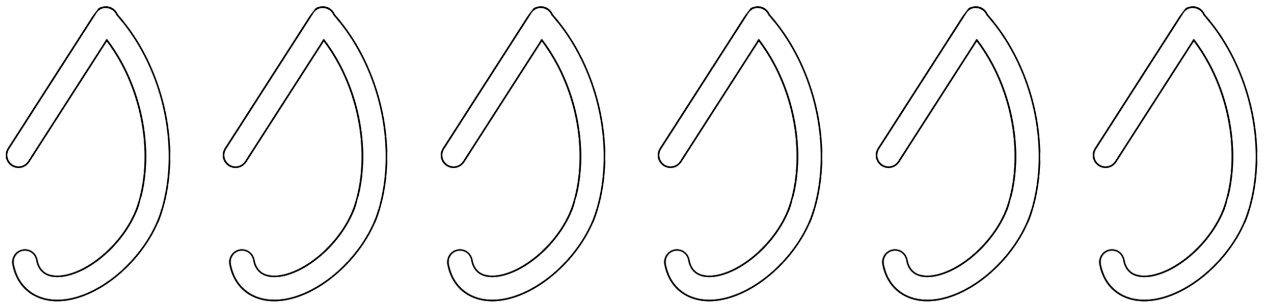
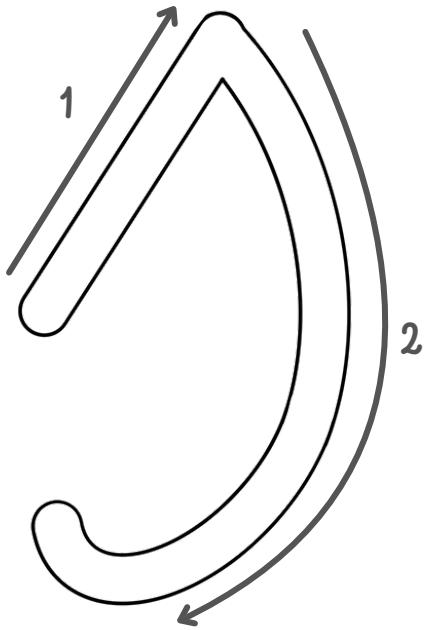

h ou t

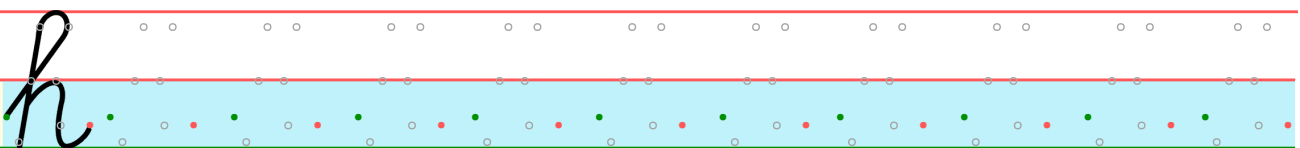
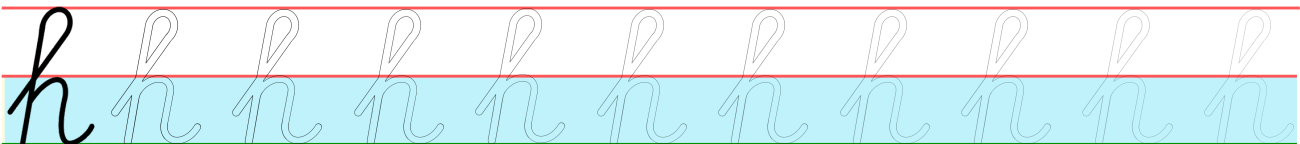
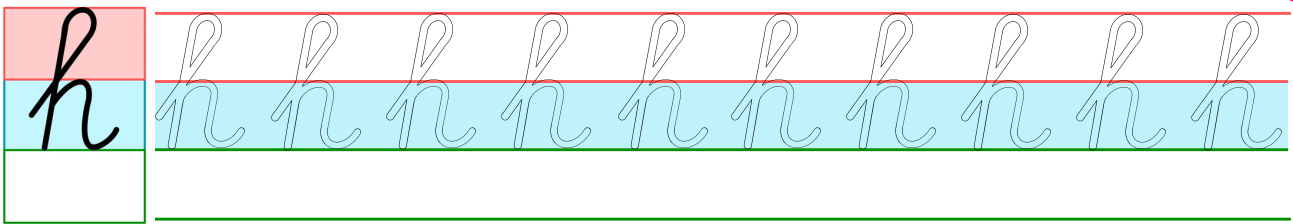
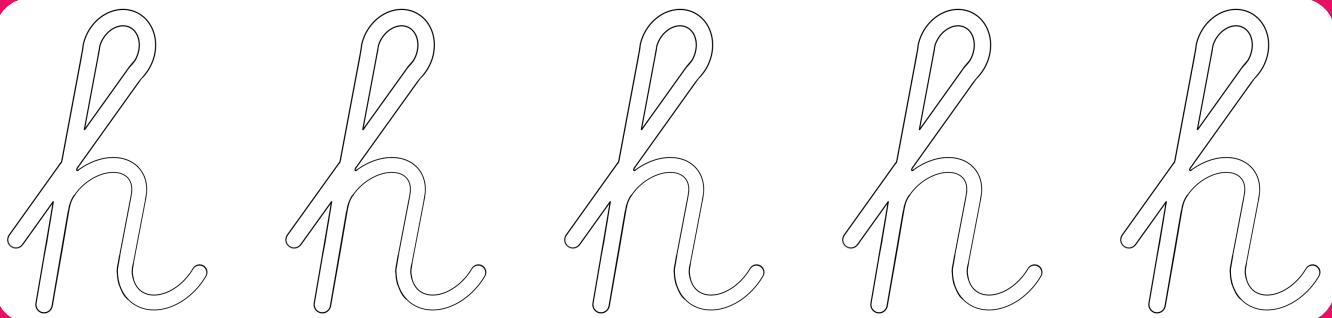
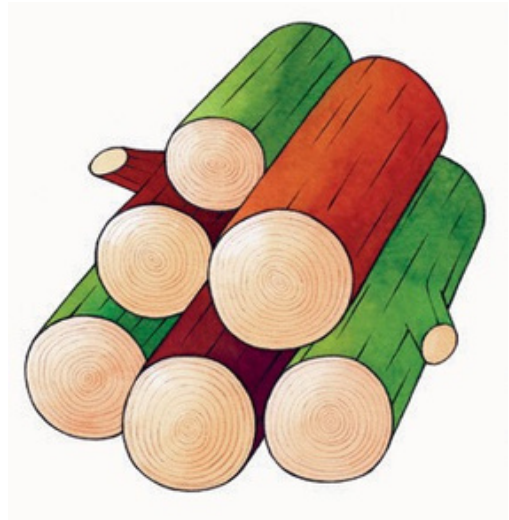
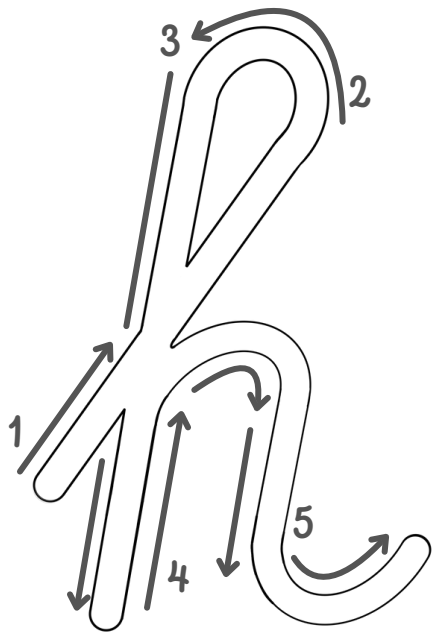

h ou t

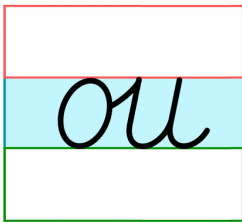
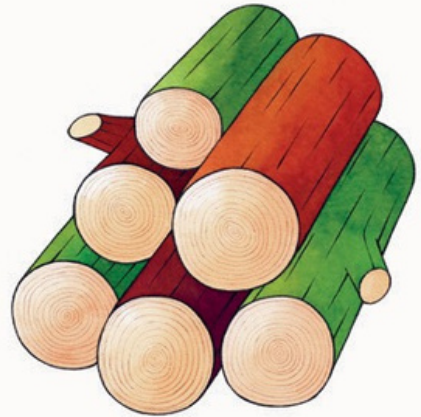
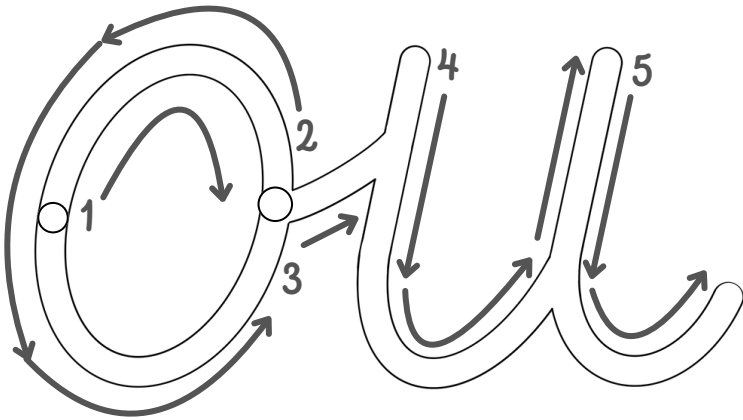

h ou t

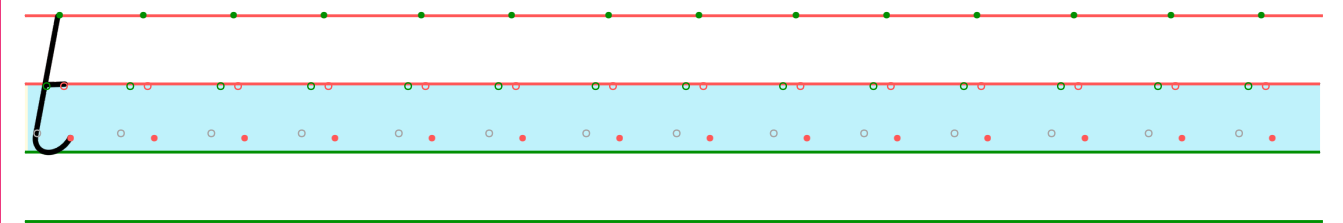
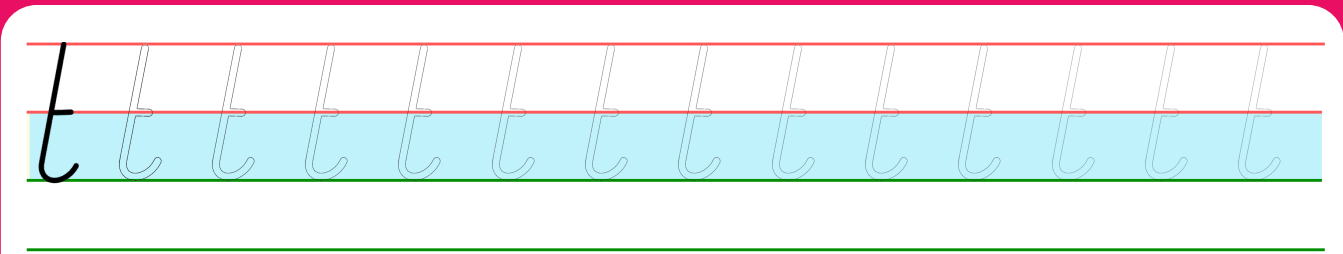
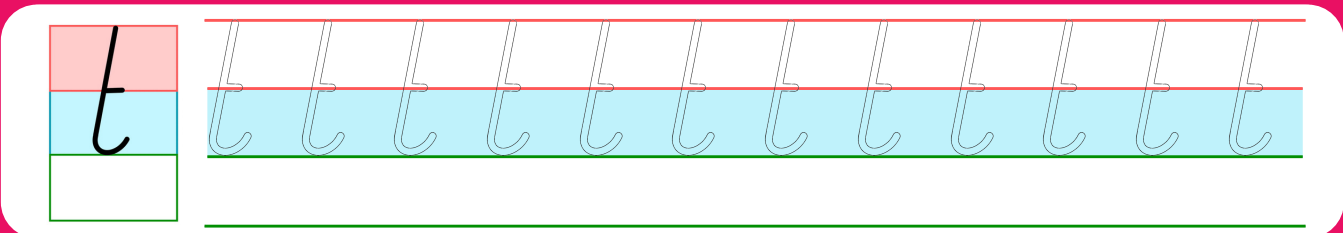
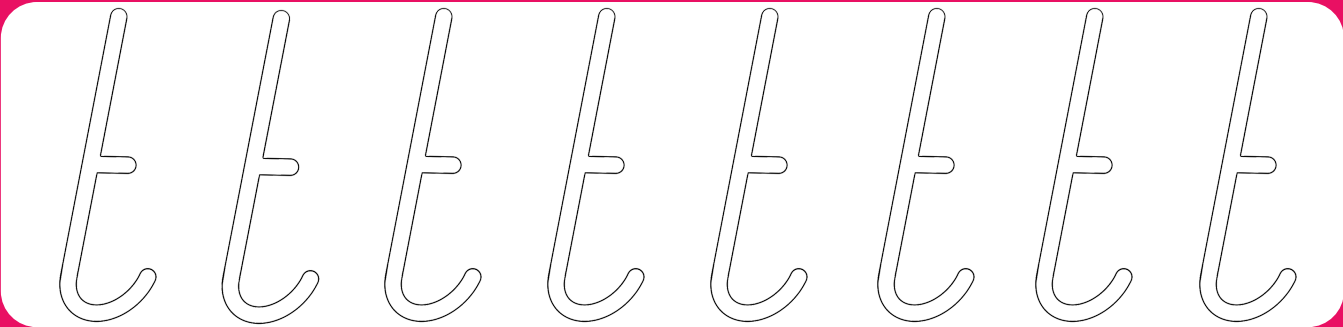
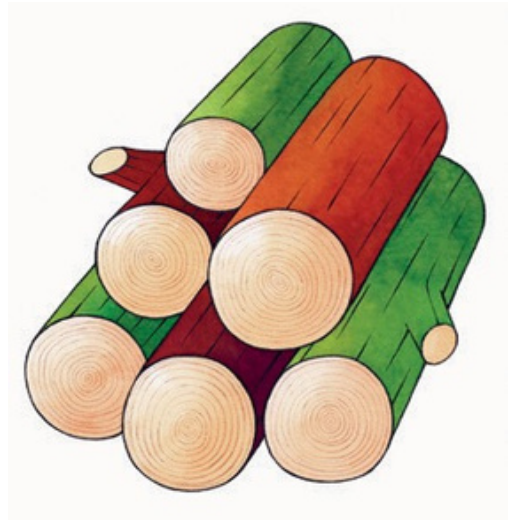
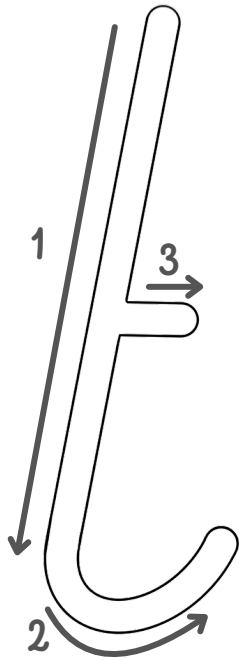

sch uu r

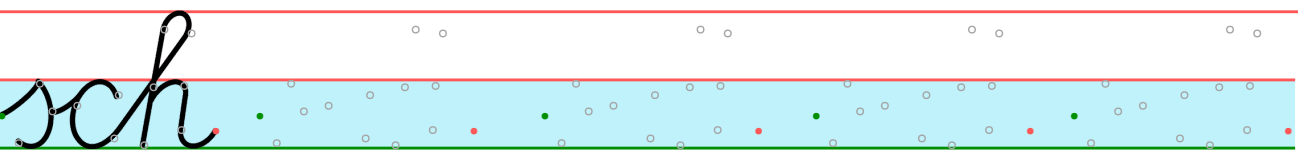
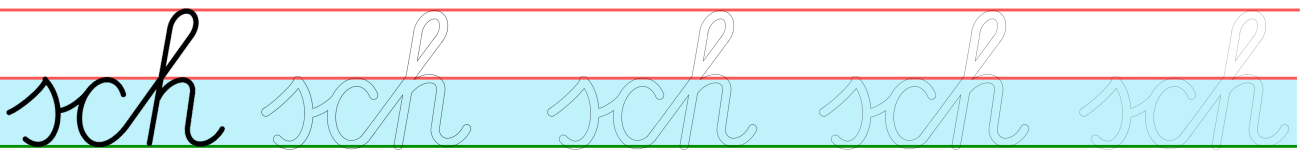
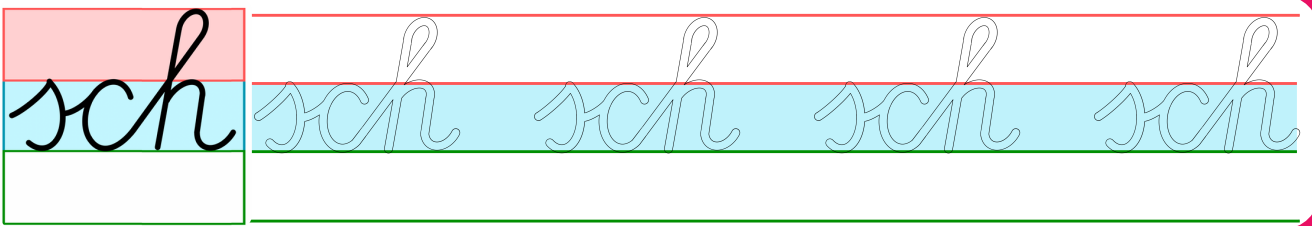
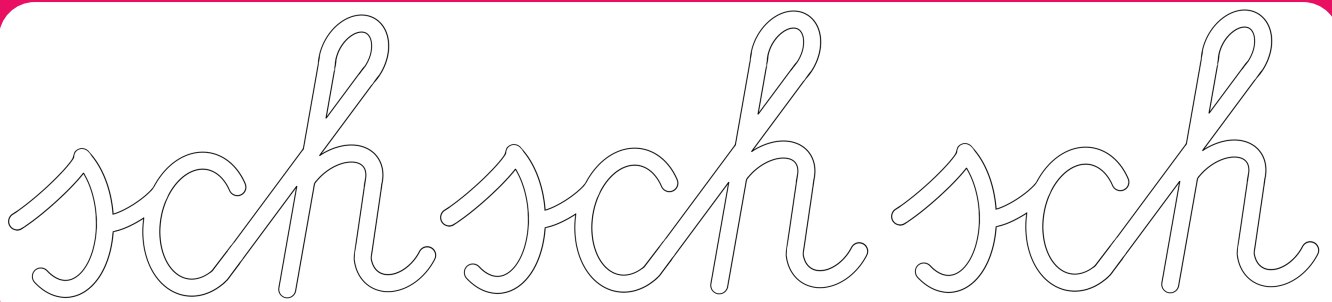
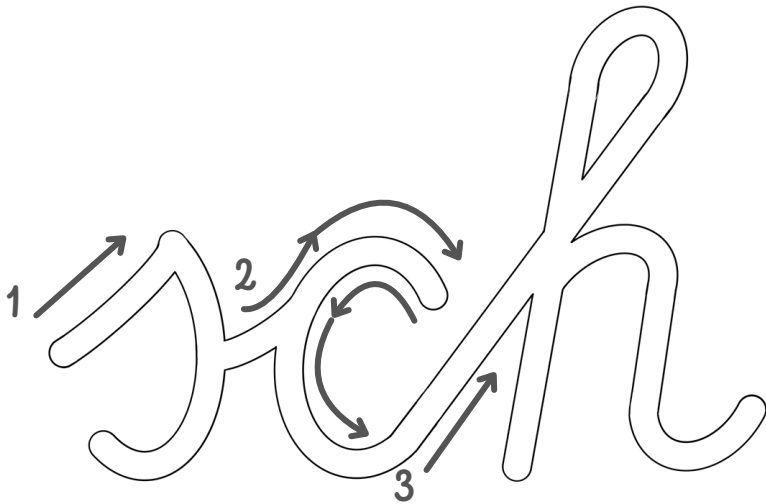

sch uu r

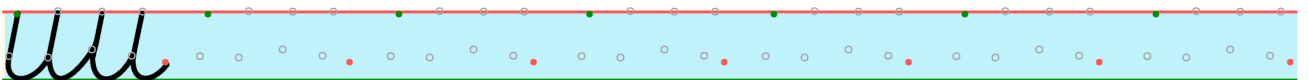
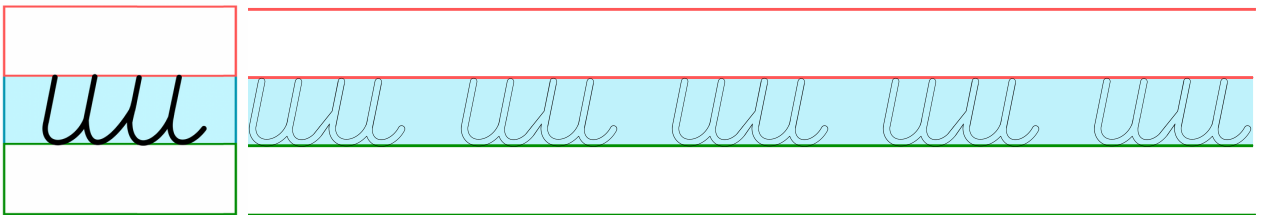
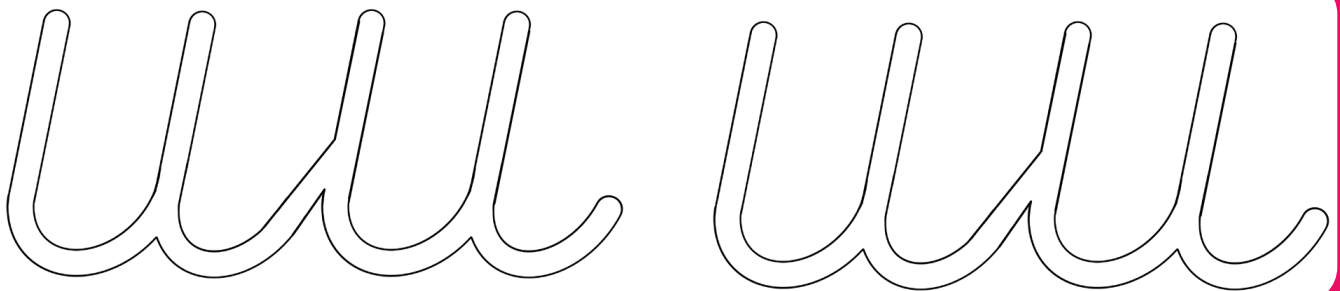
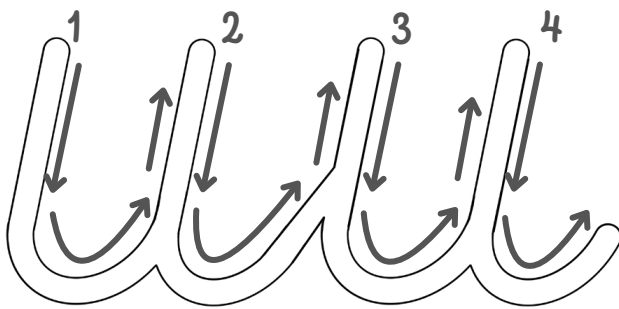

sch uu r

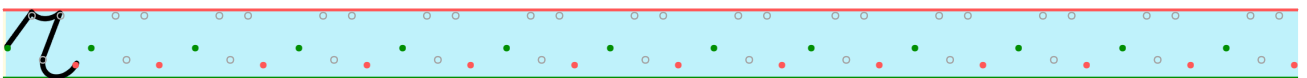
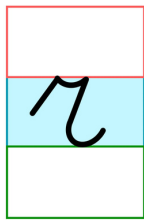
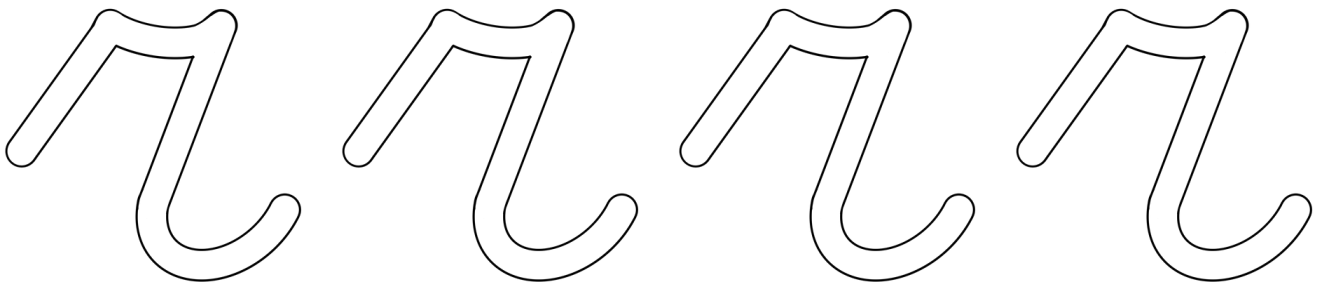
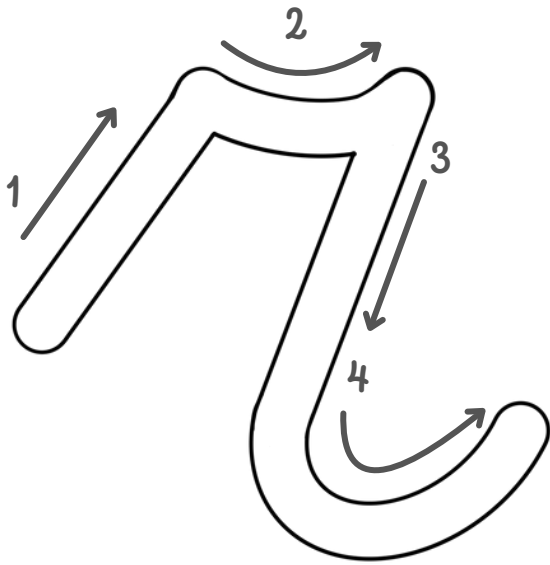

l a ch

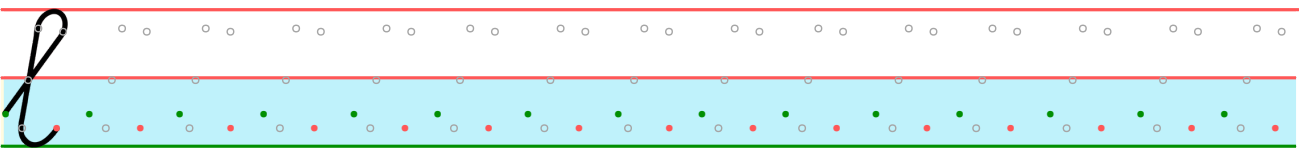
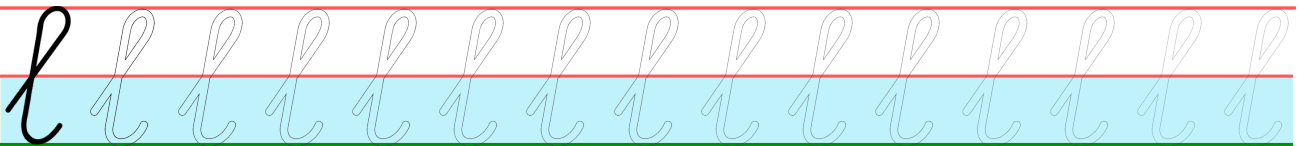
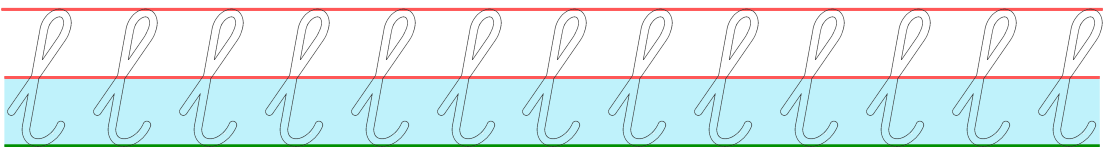
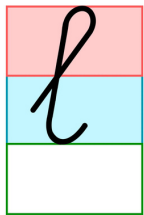
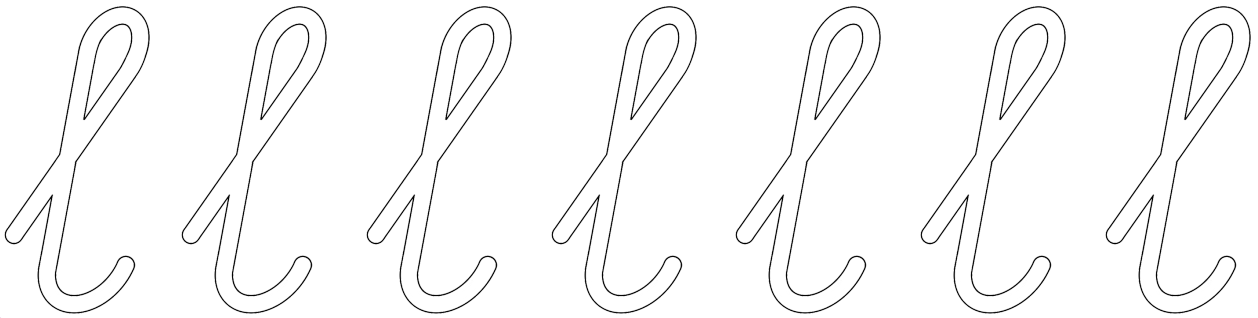
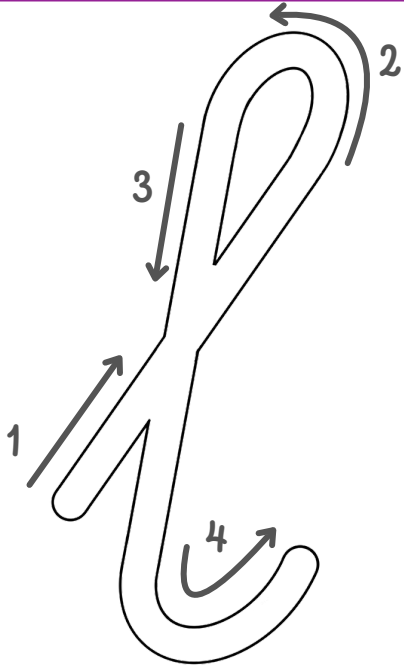

l a ch

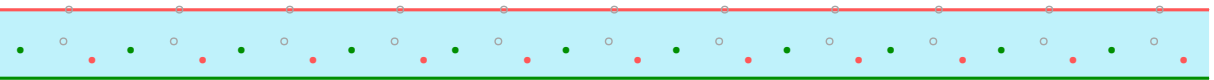
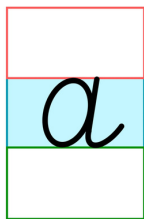
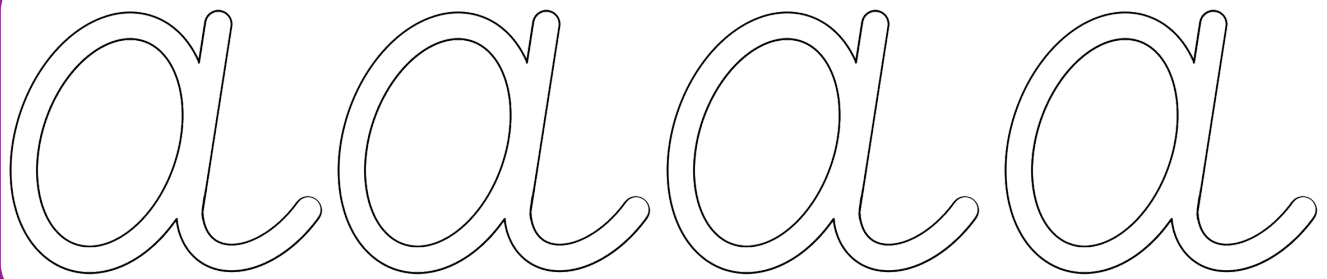
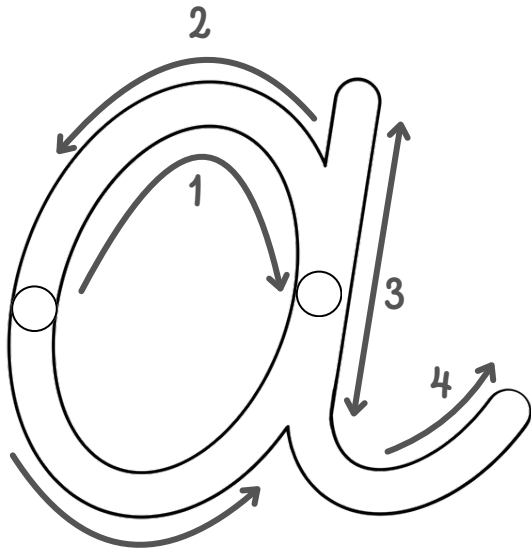

l a ch

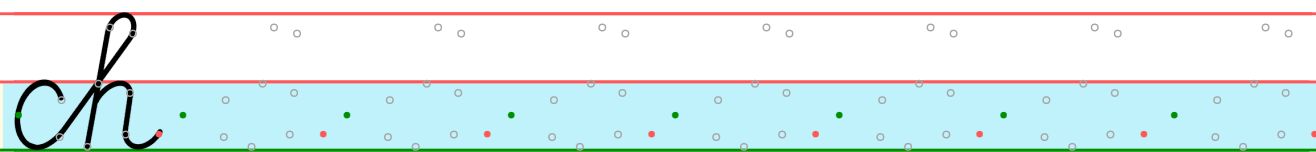
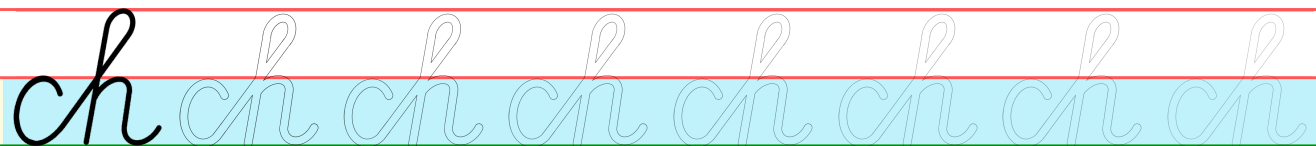
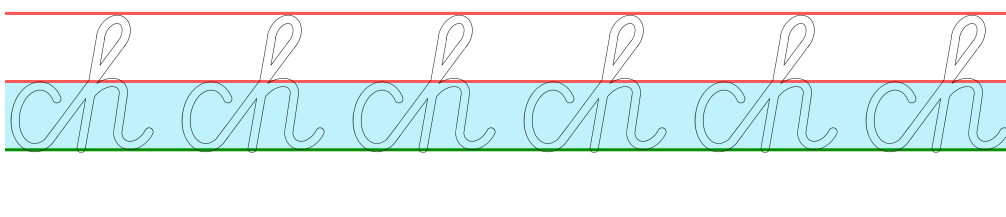
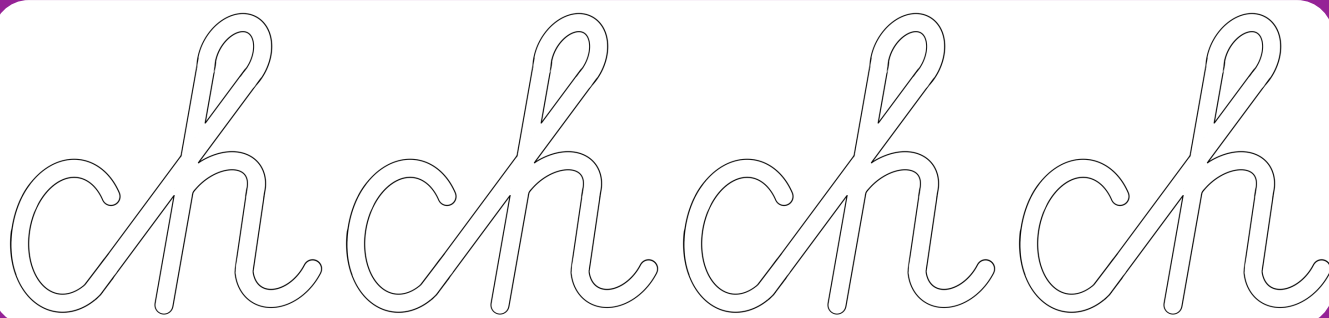
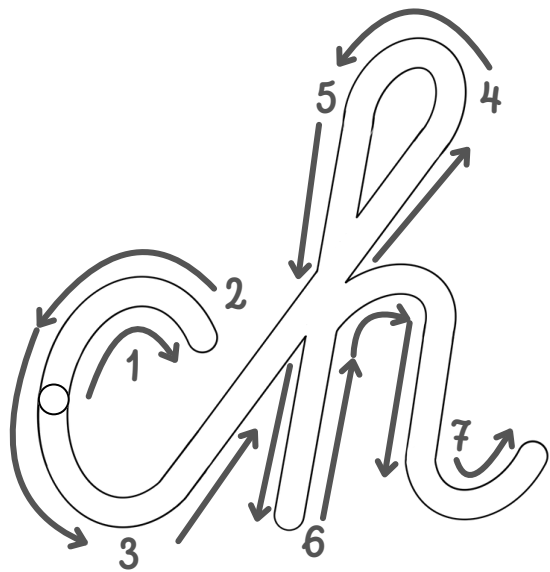

ei

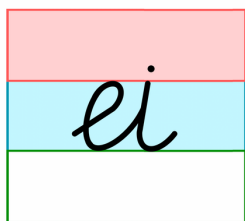
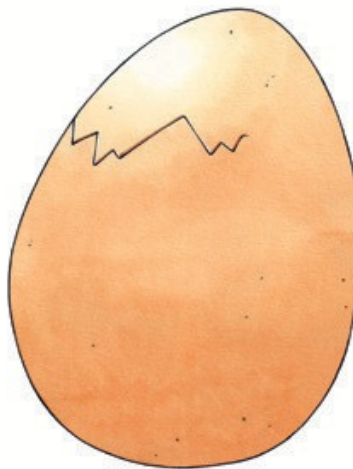
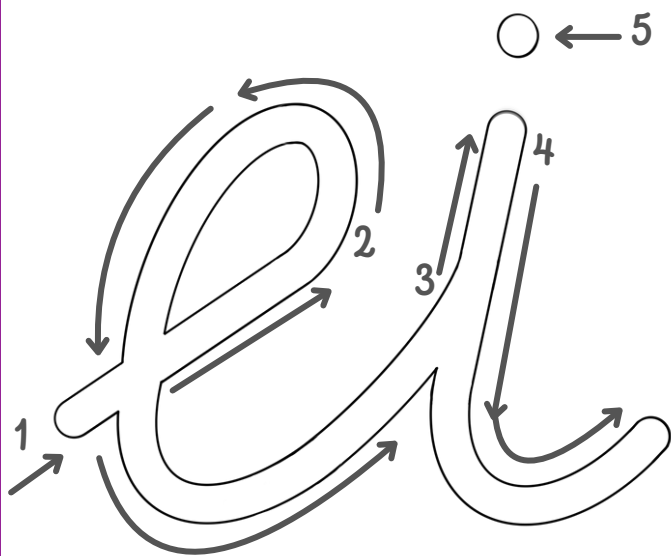

p au w

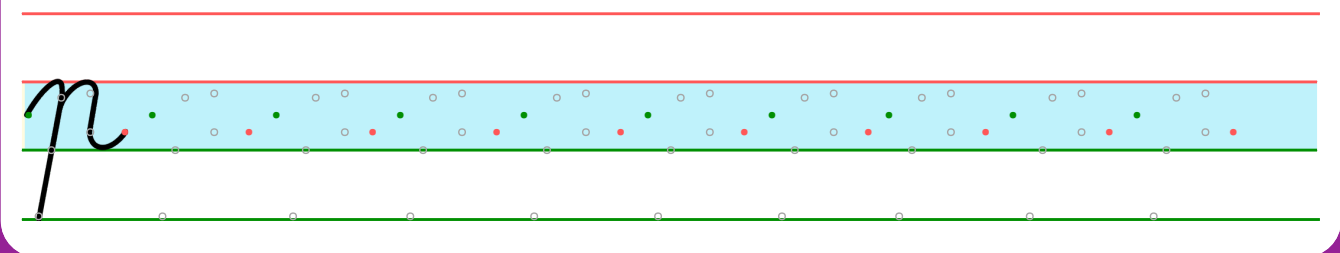
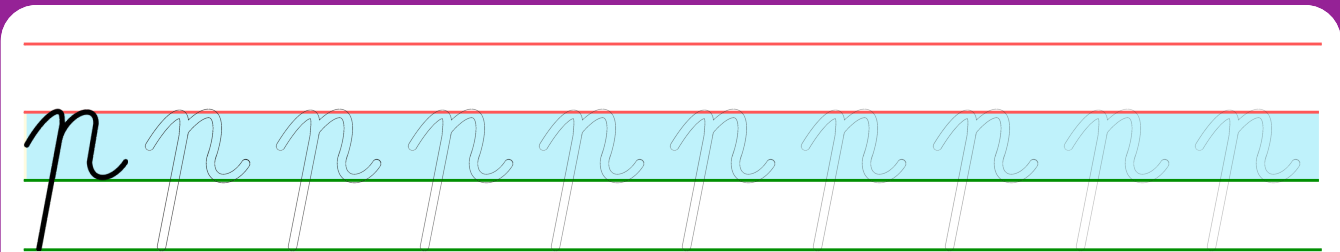
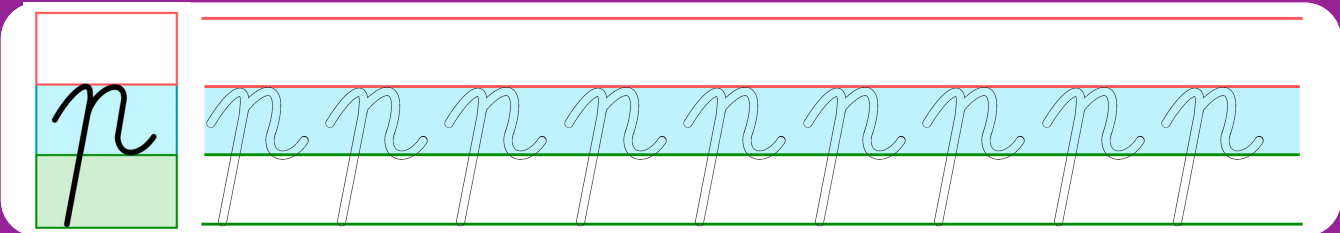
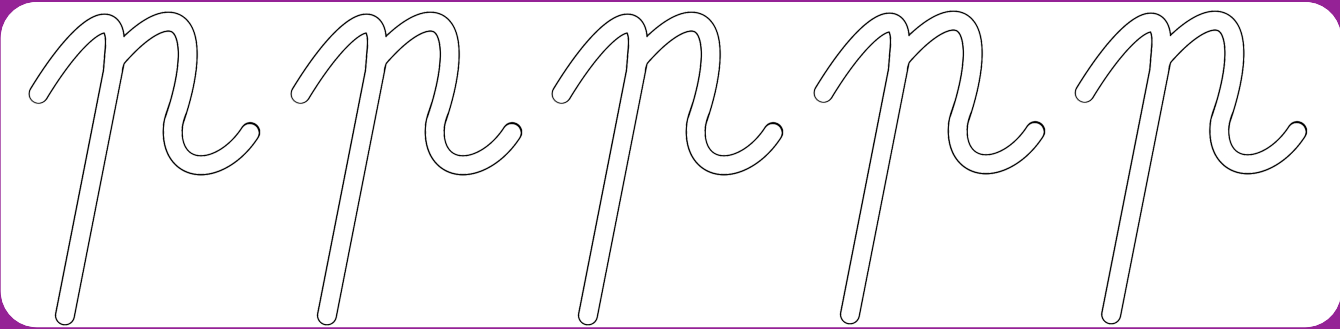
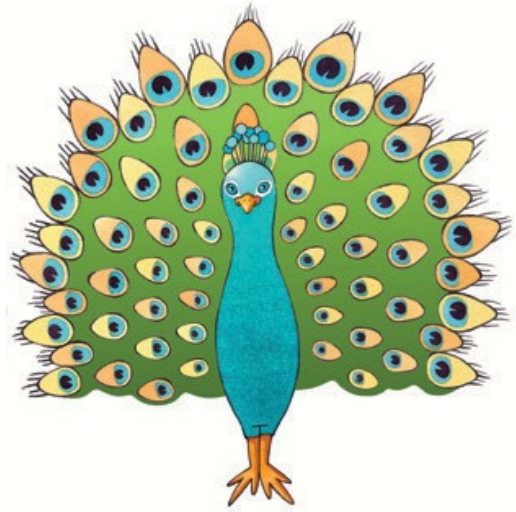
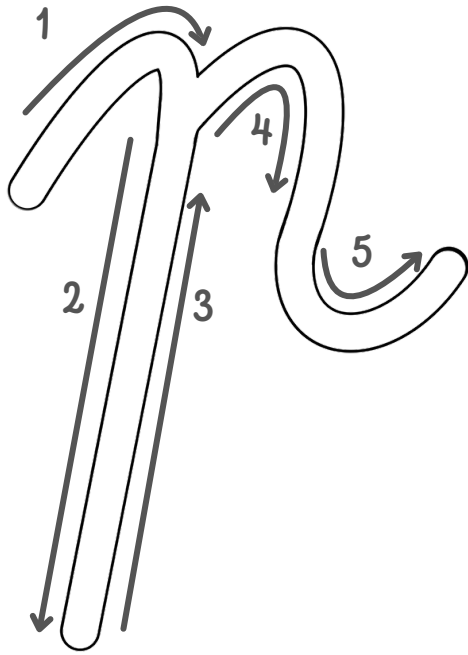

p au w

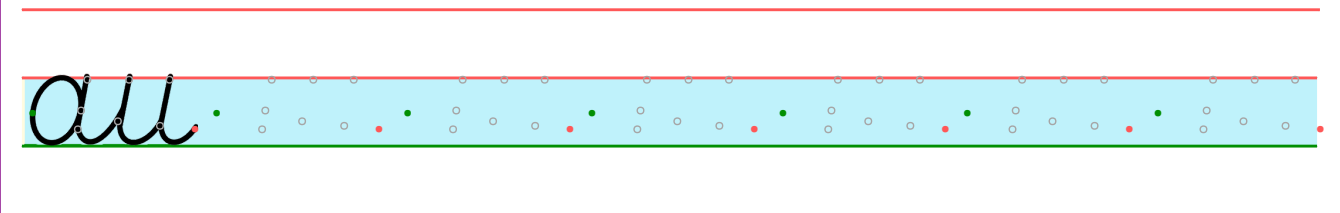
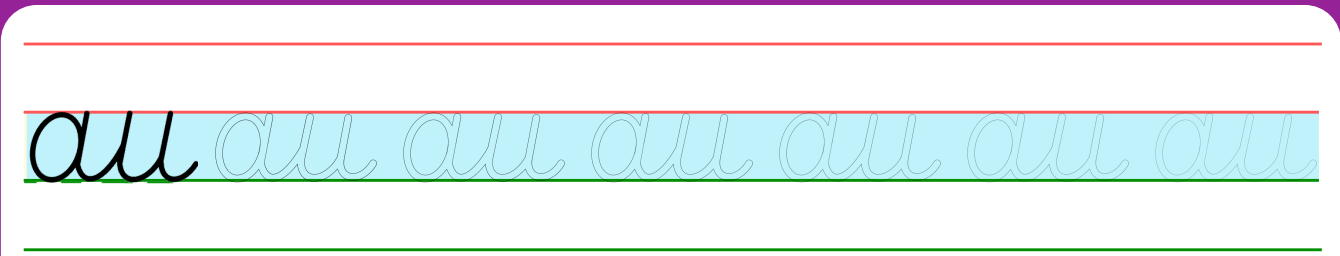
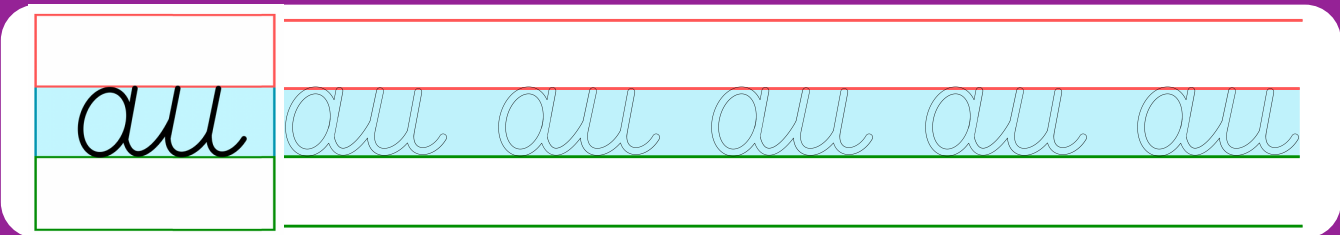
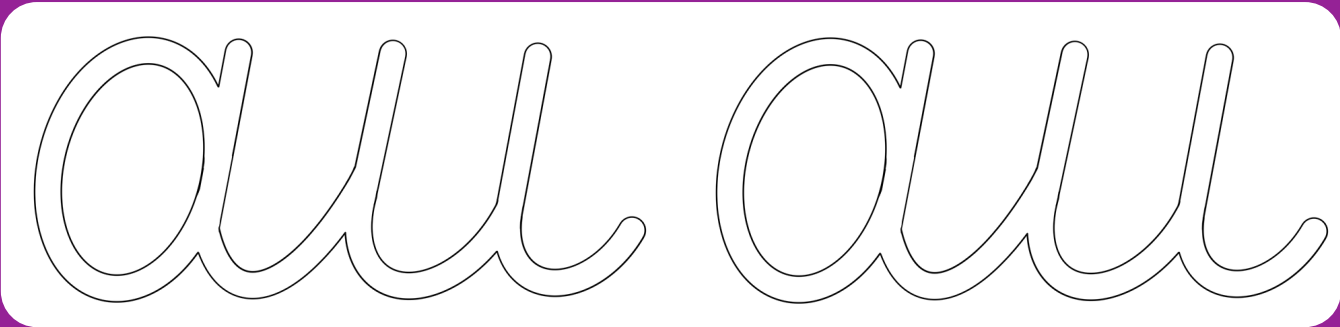
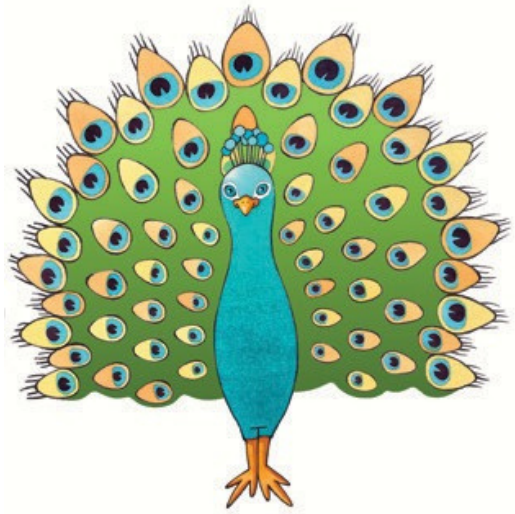
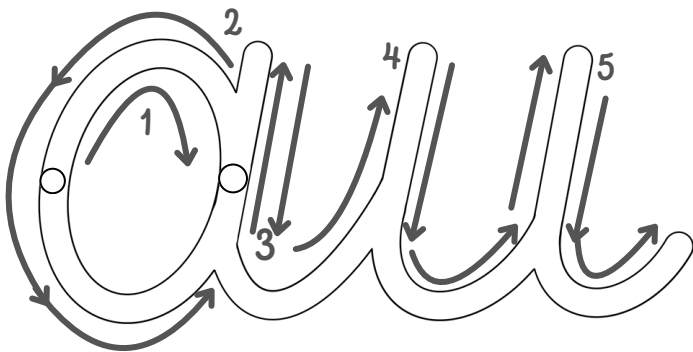

p au w

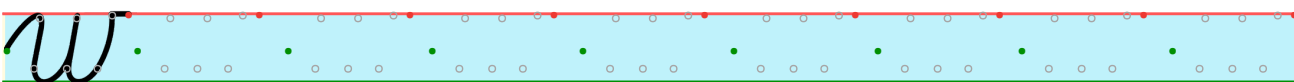
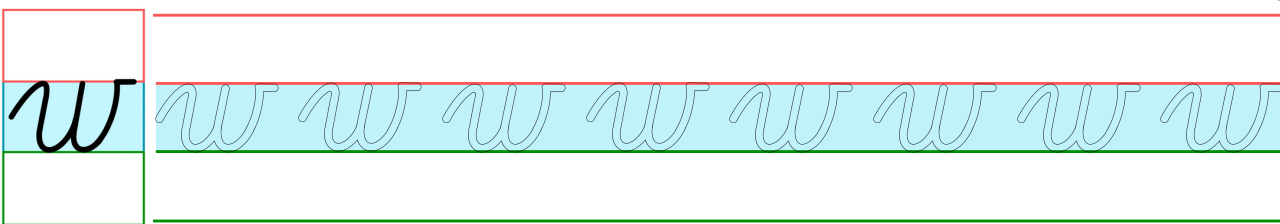
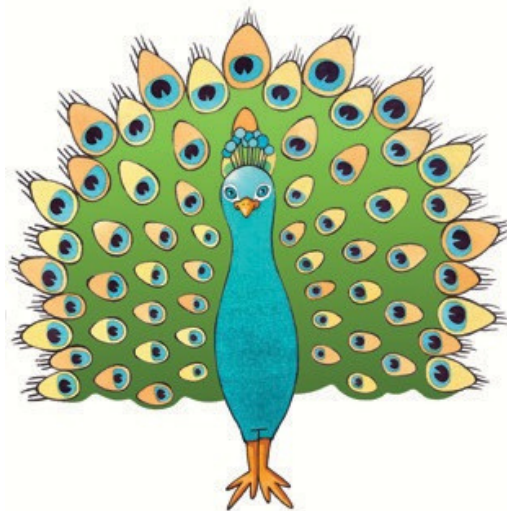
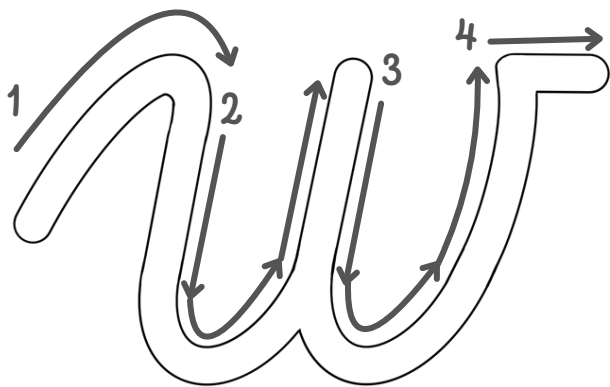

r i n g

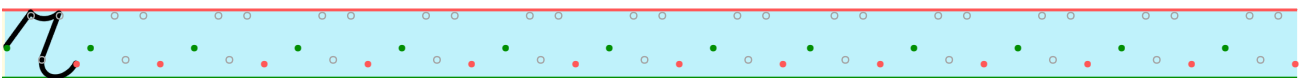
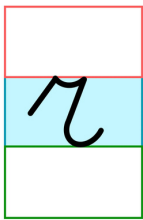
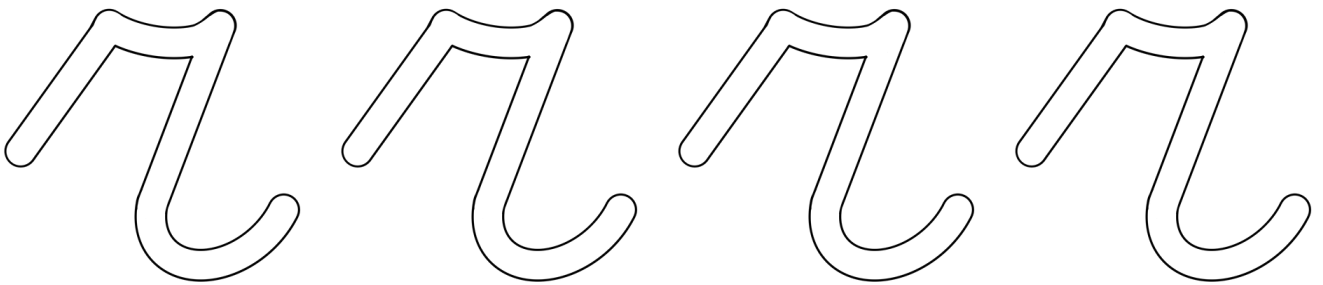
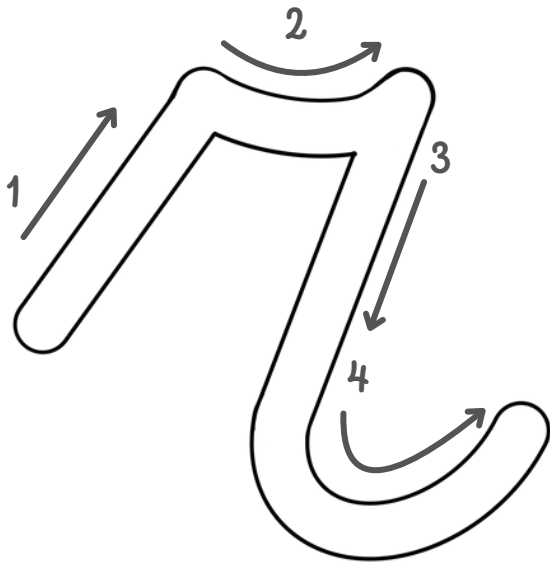

r i ng

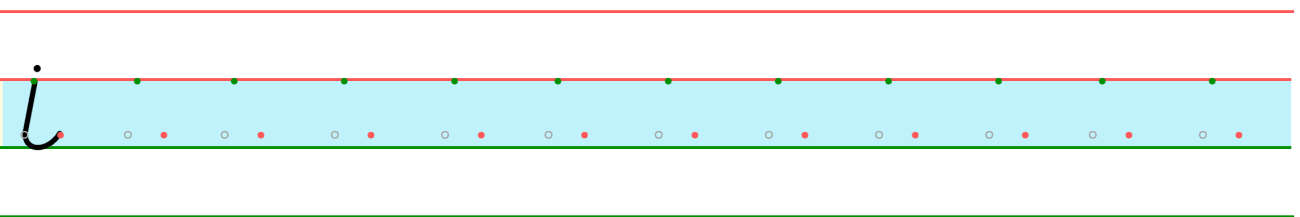
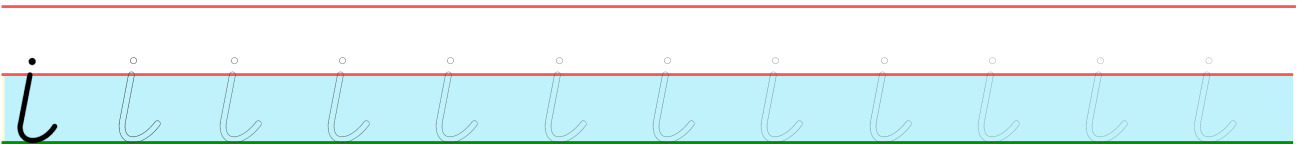
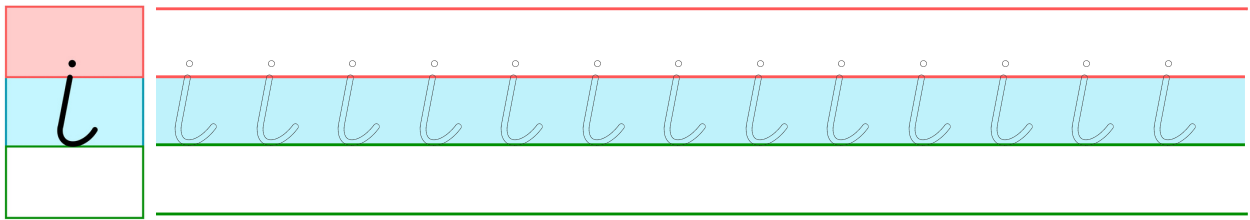
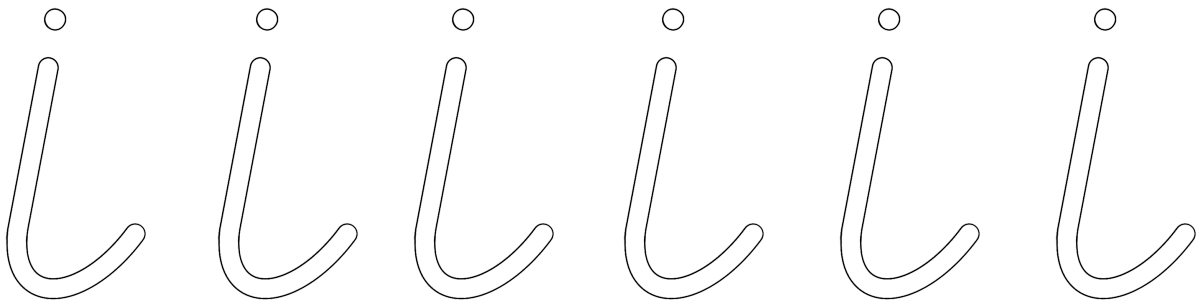
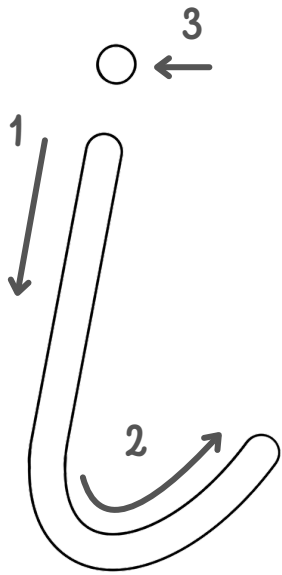

r i ng

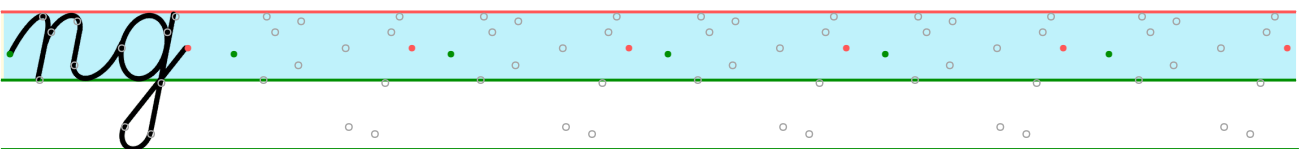
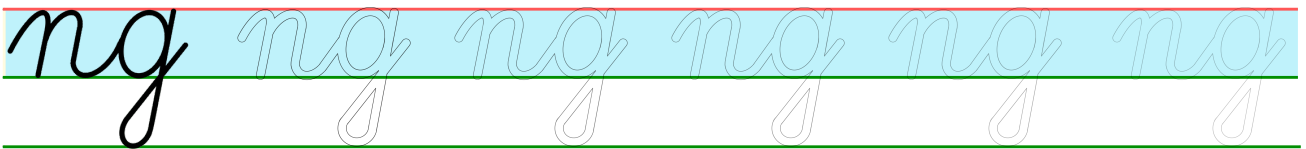
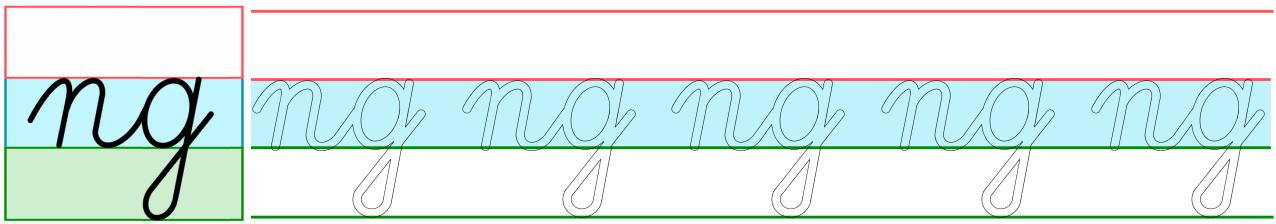
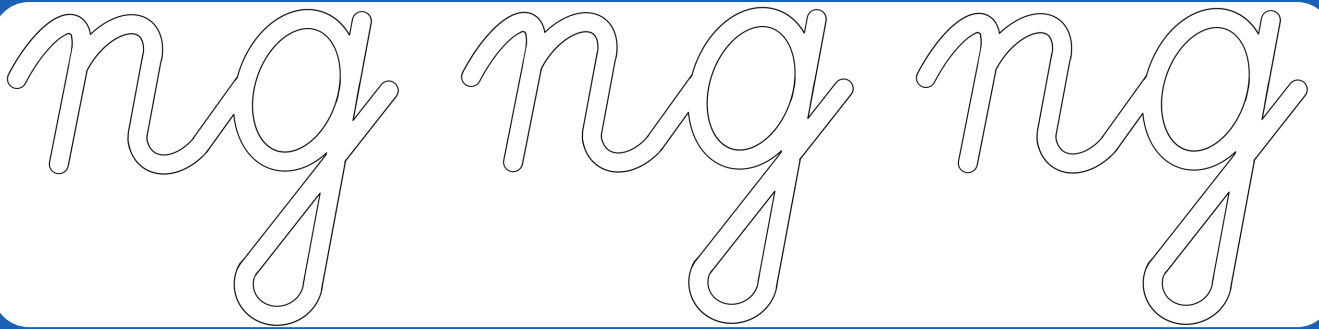
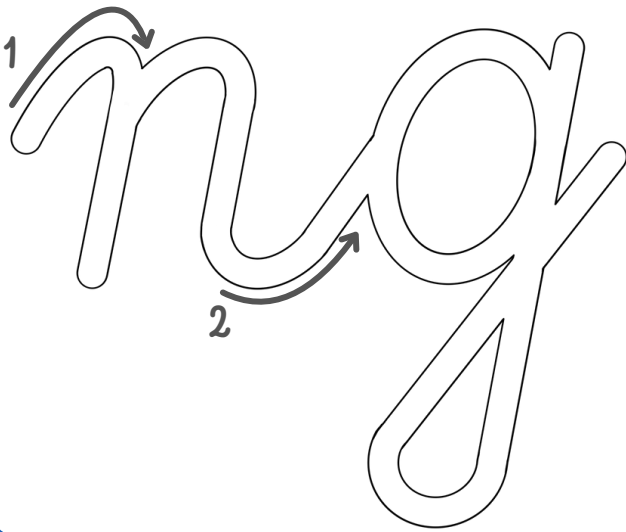

b a nk

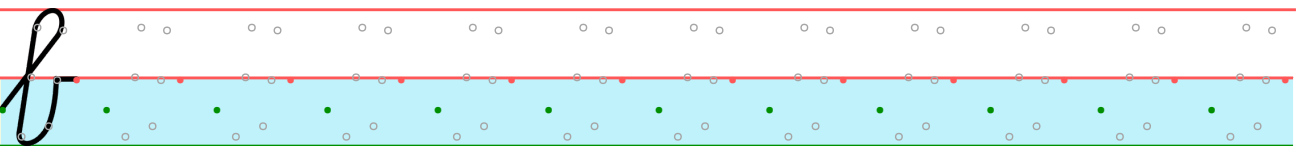
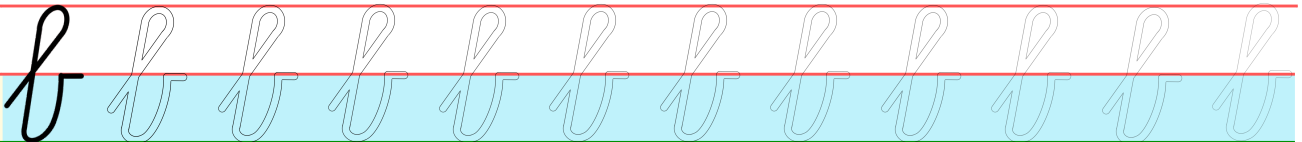
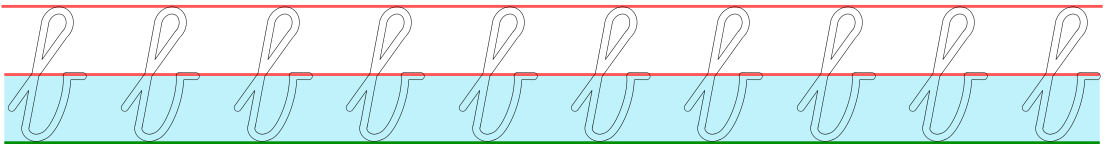
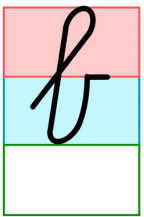
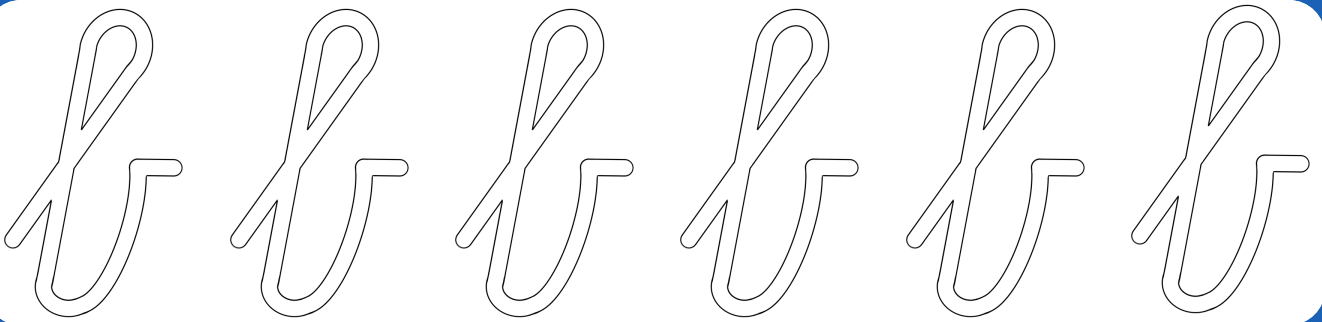
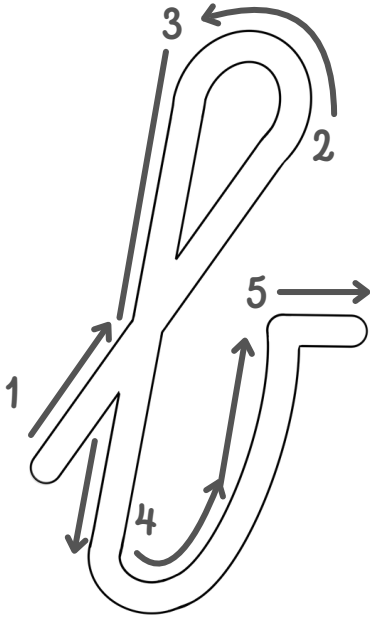

b a nk

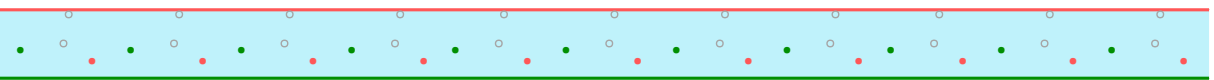
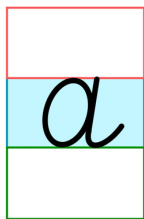
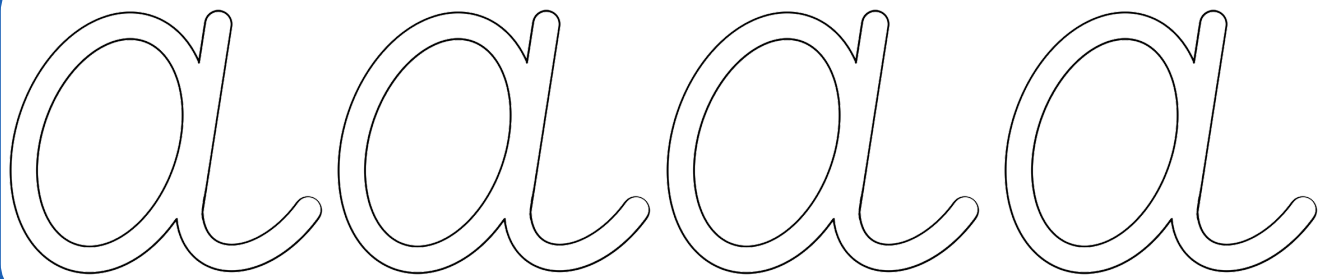
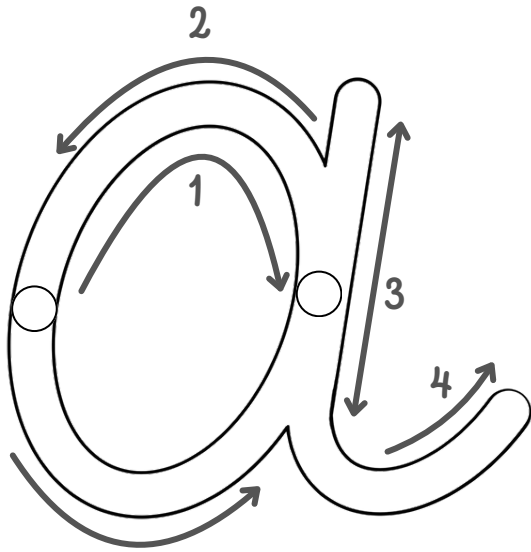

b a nk

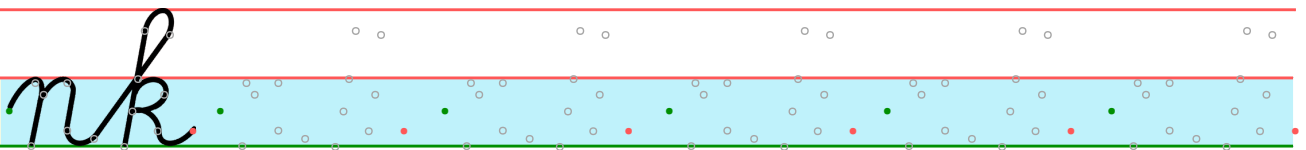
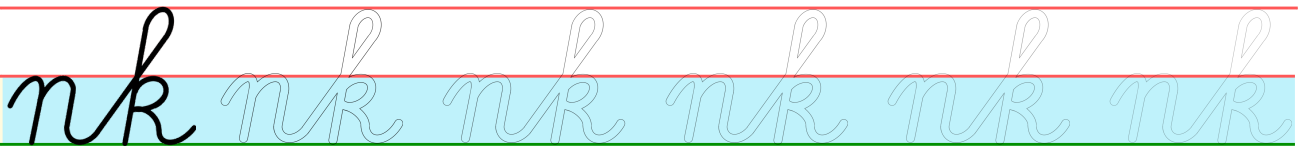
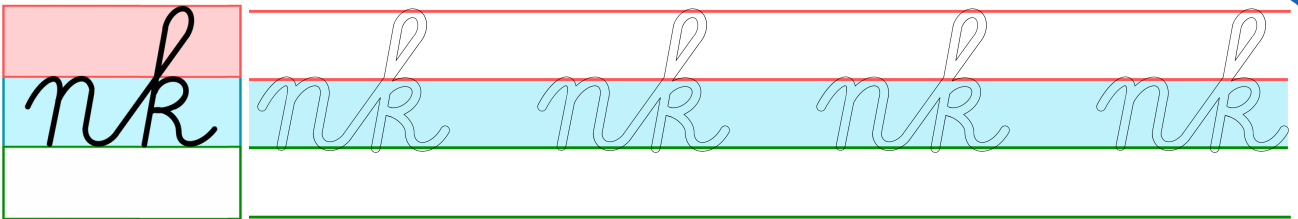
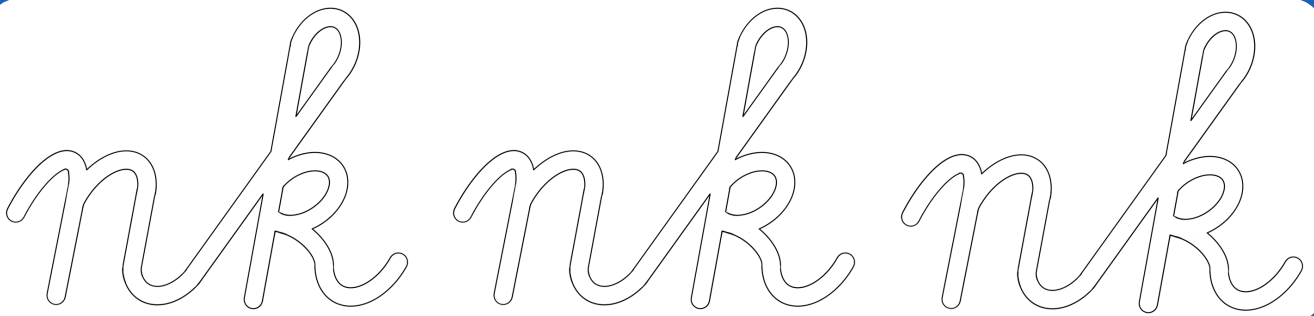
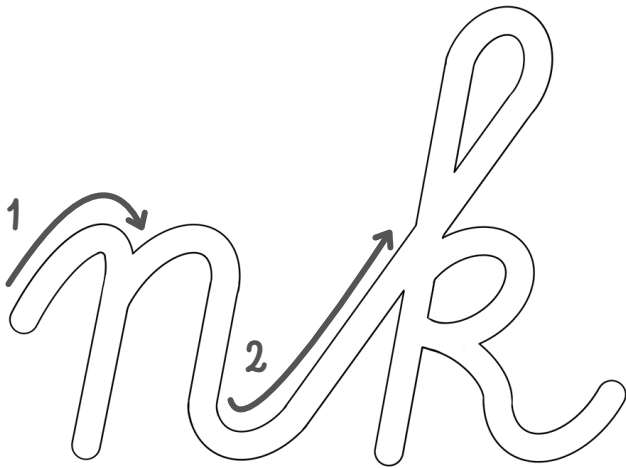

h

aai

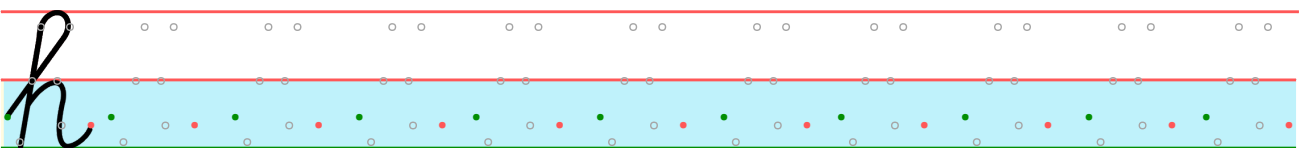
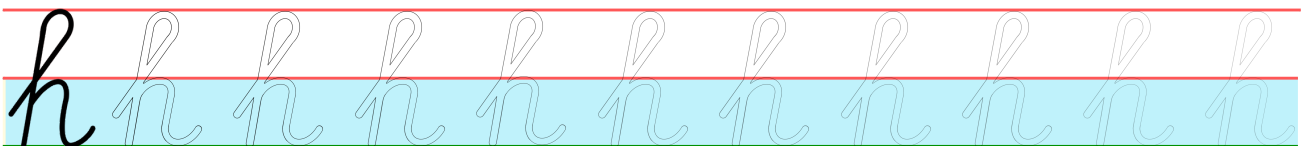
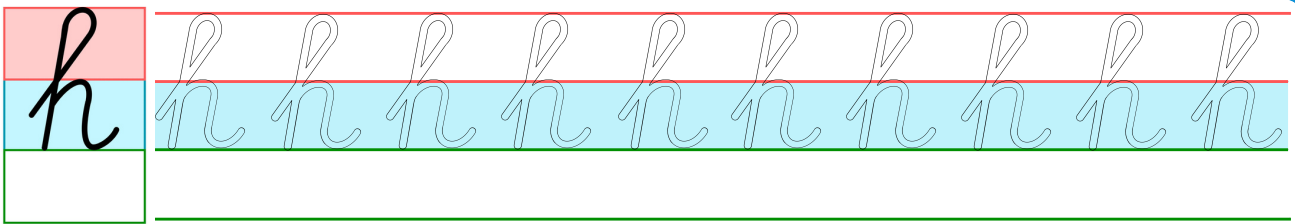
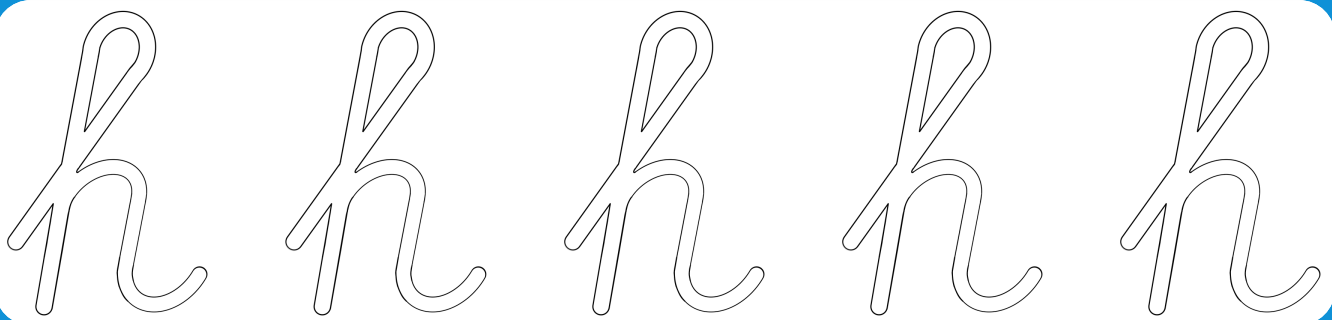
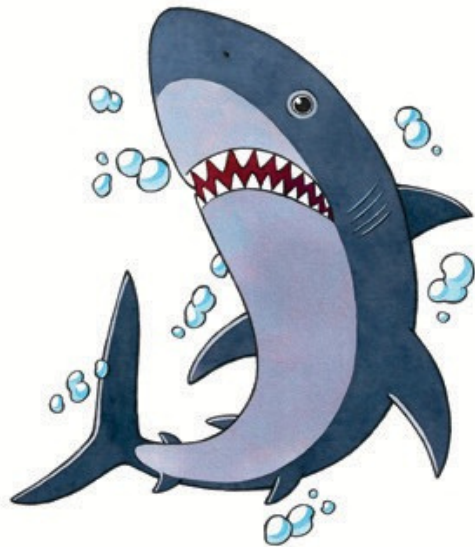
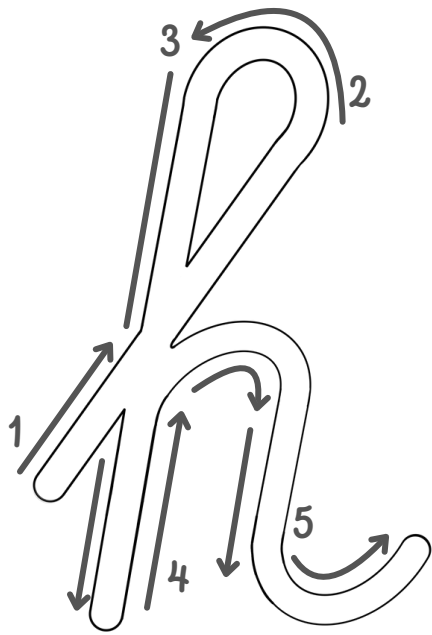

h

aai

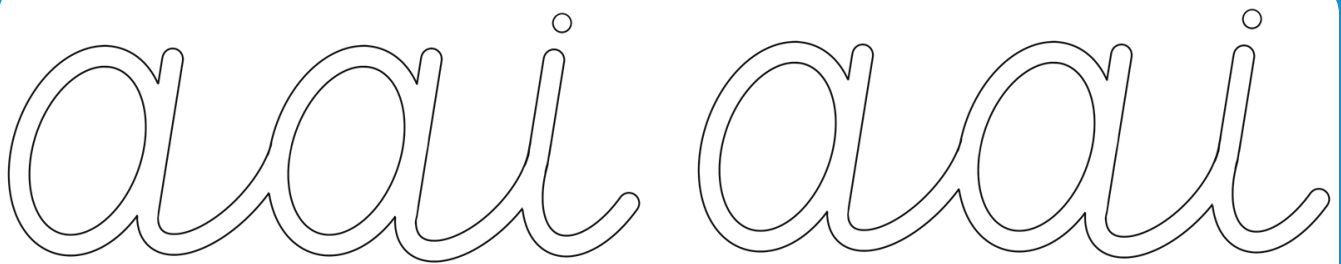
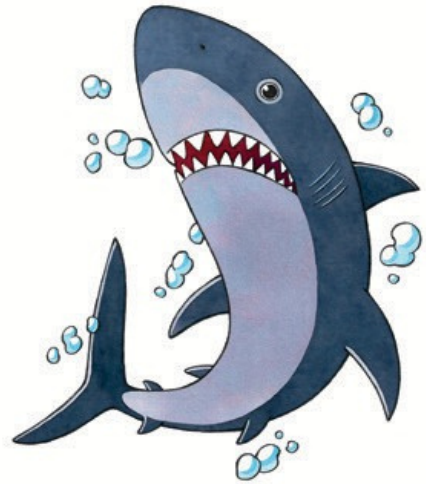
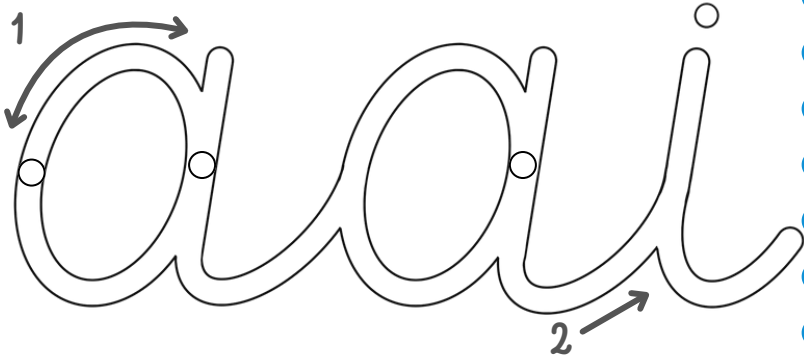

aai



aai

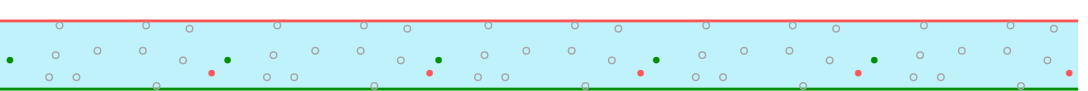

k

ooi

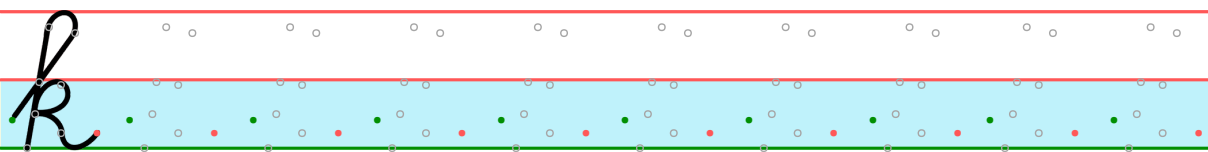
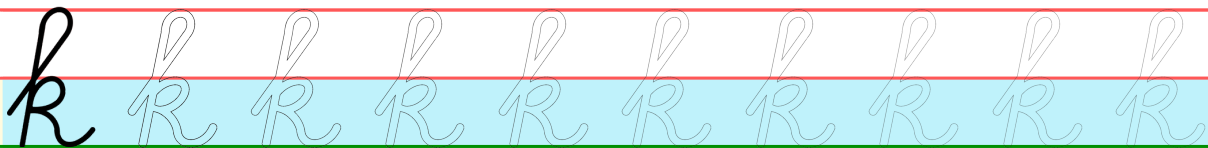
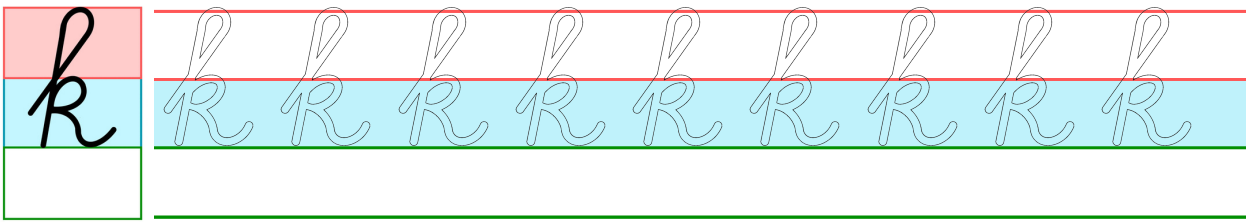
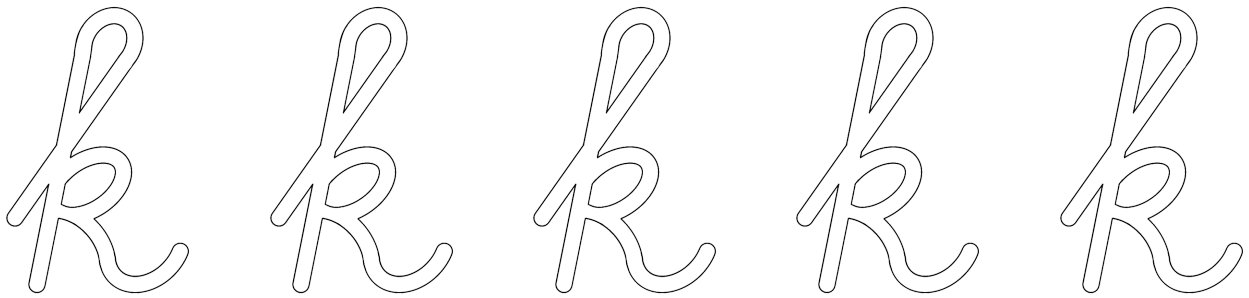
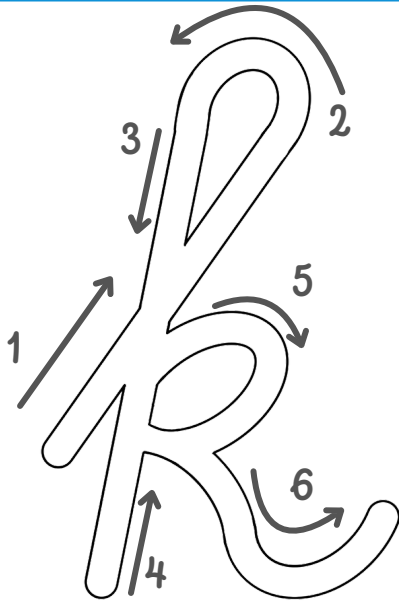

k

ooi

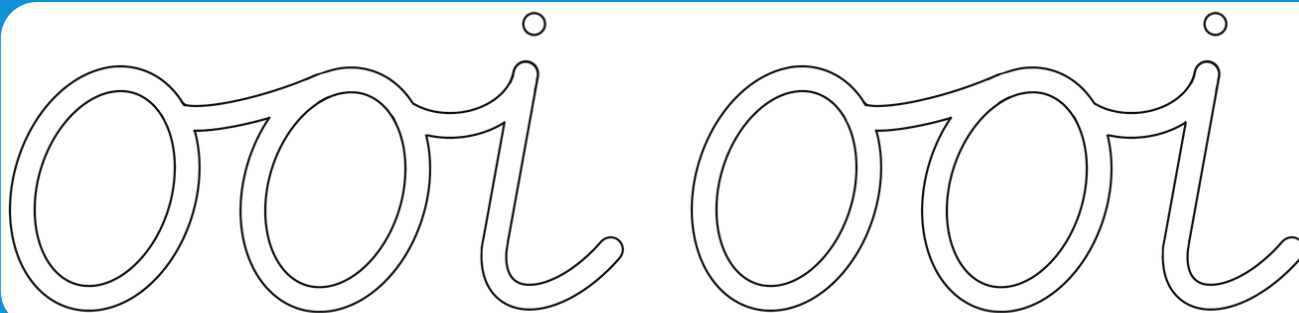
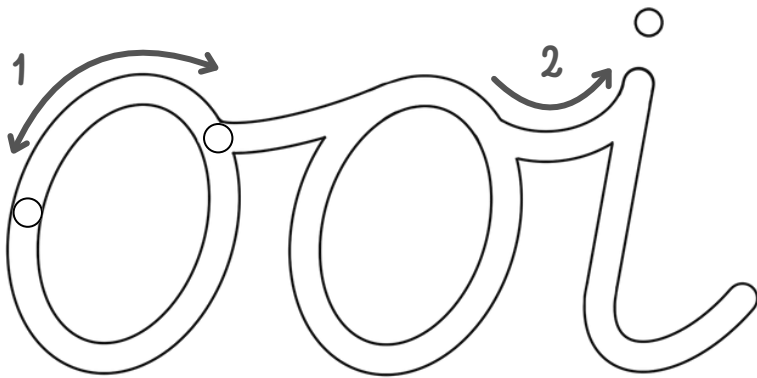

ooi

ooi ooi ooi ooi ooi ooi

ooi ooi ooi ooi ooi ooi ooi

ooi

r

oei

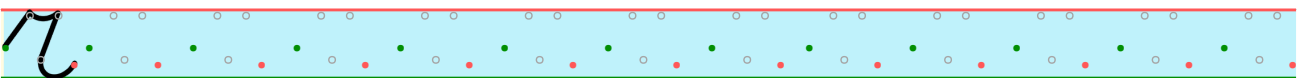
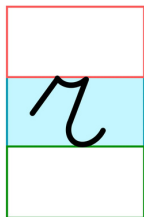
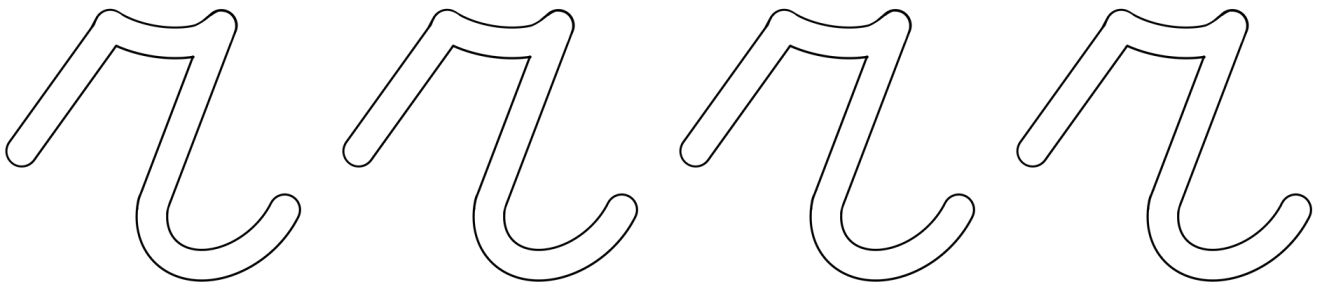
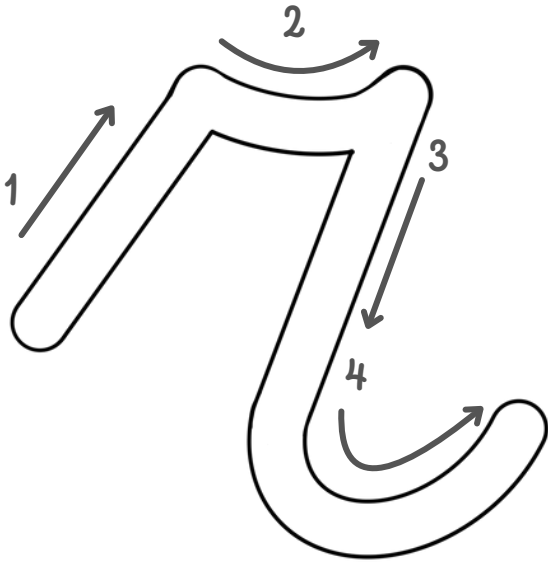

r

oei

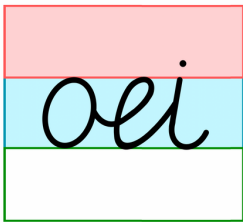
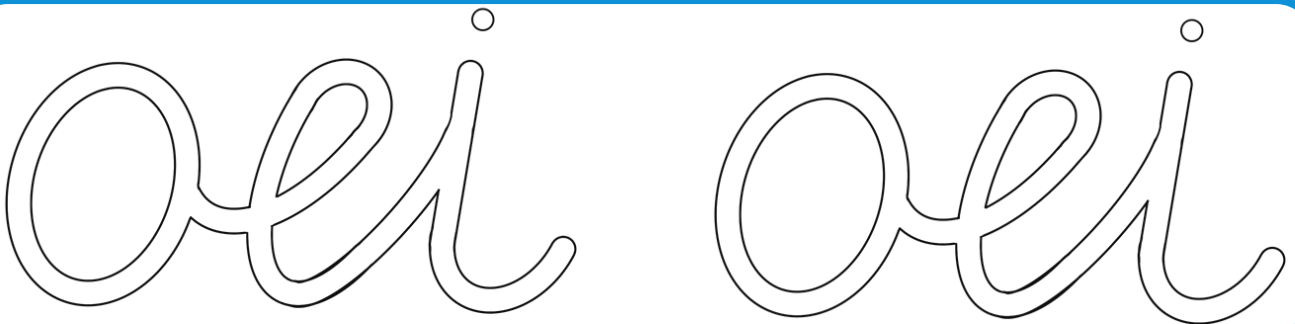
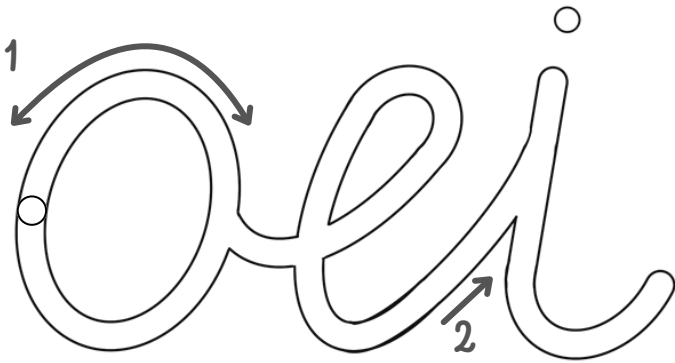

k

ieuw

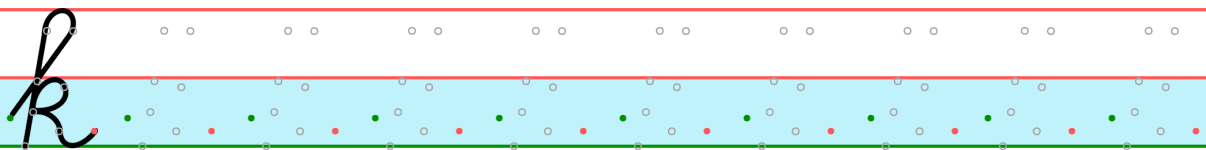
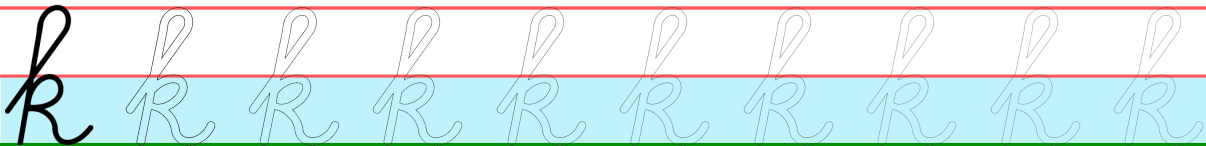
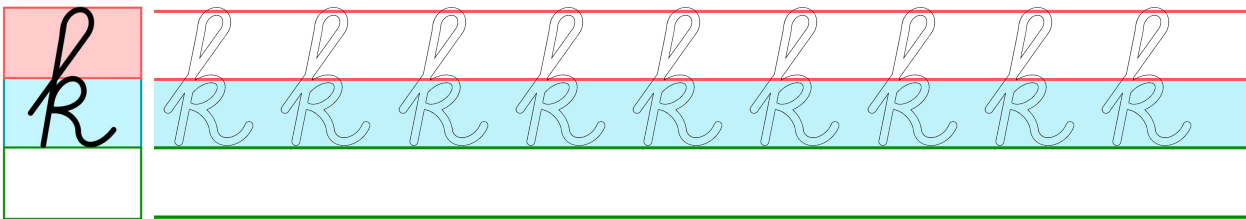
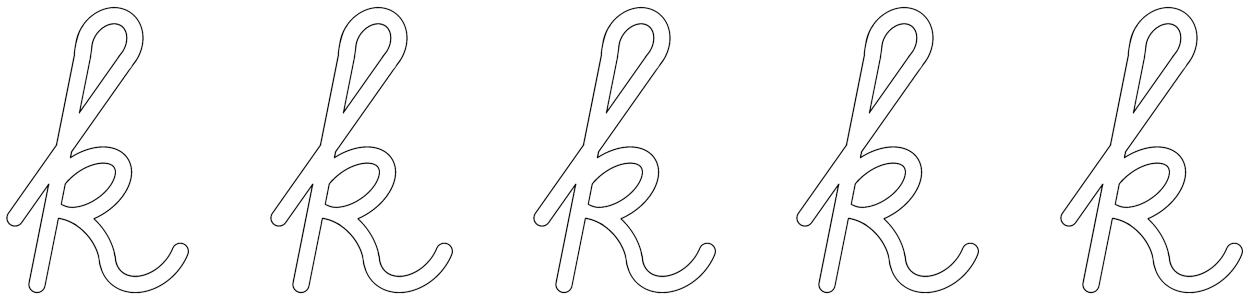
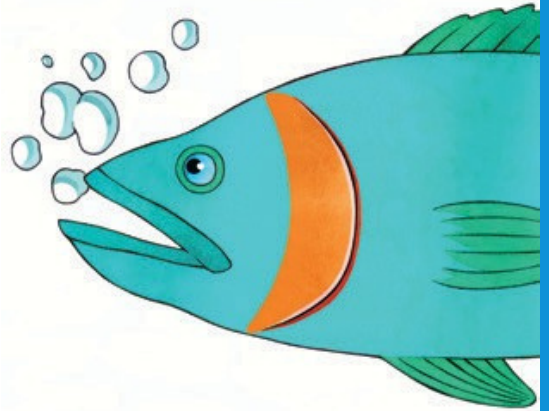
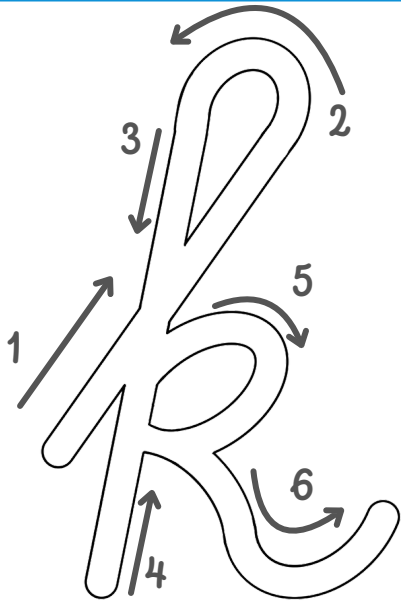

k

ieuw

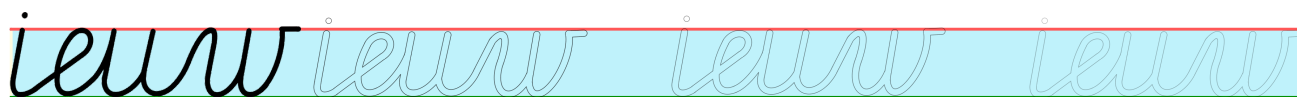
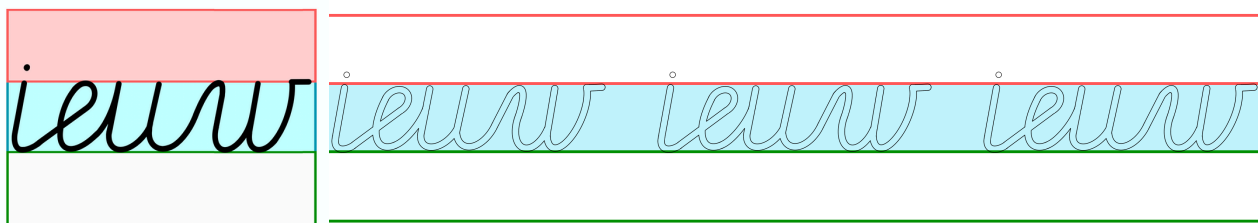
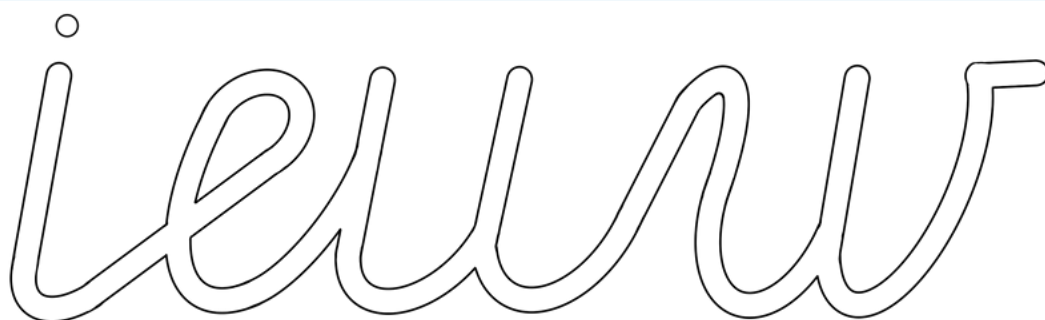
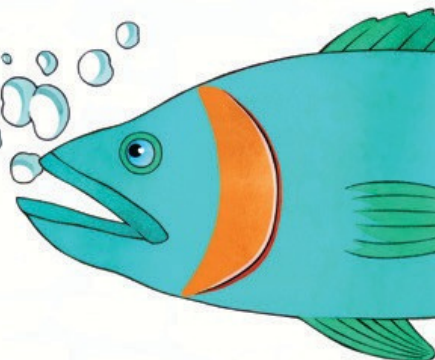
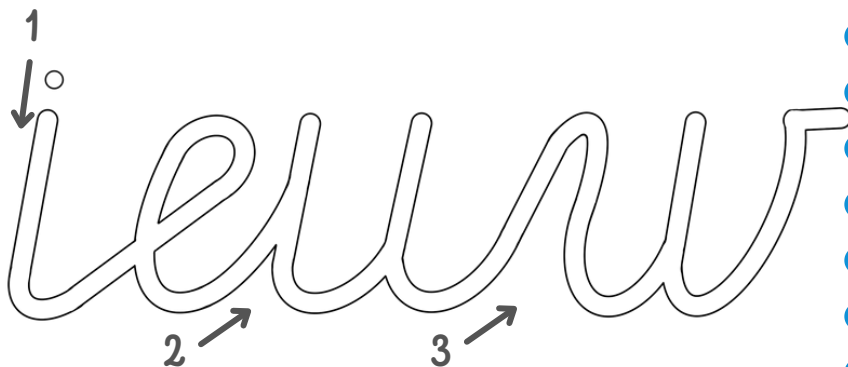

I eeuw

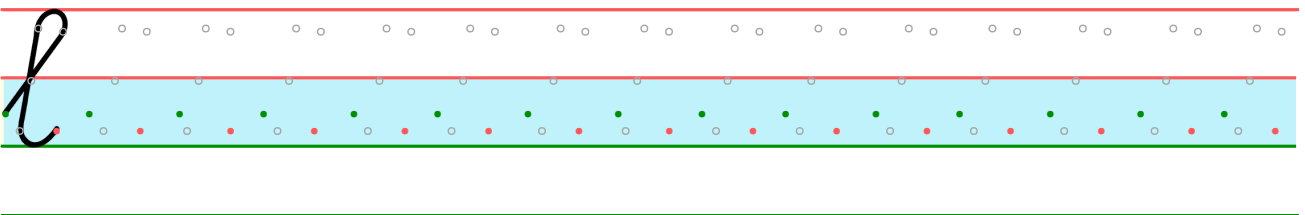
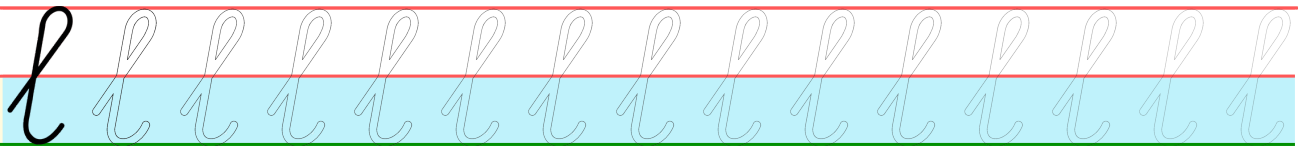
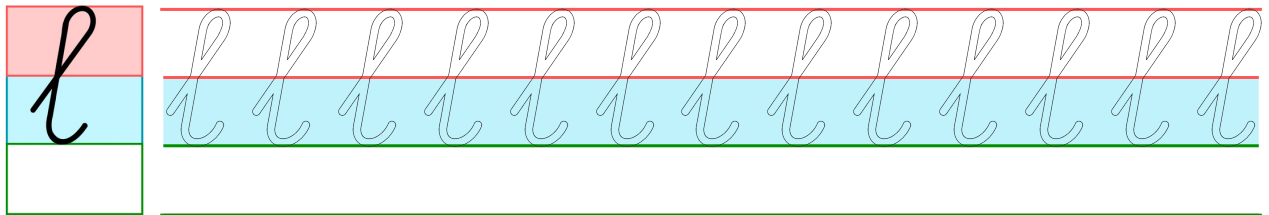
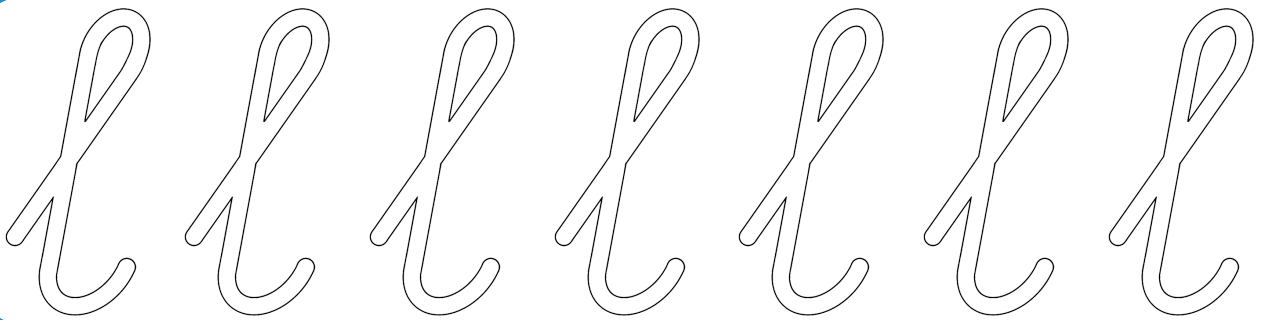
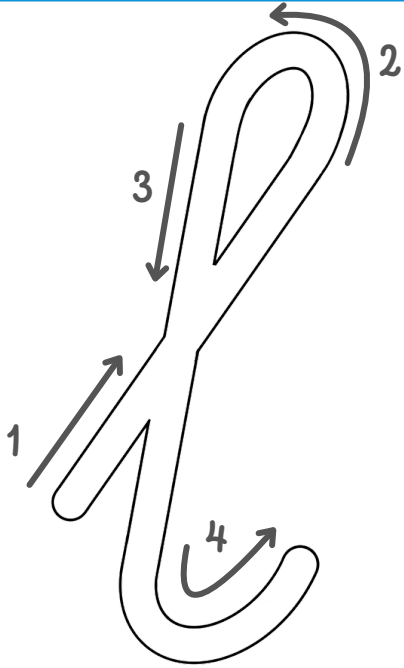

I eeuw

1 2 3



eeuw

eeuw eeuw eeuw eeuw

eeuw eeuw eeuw eeuw

eeuw . . .